

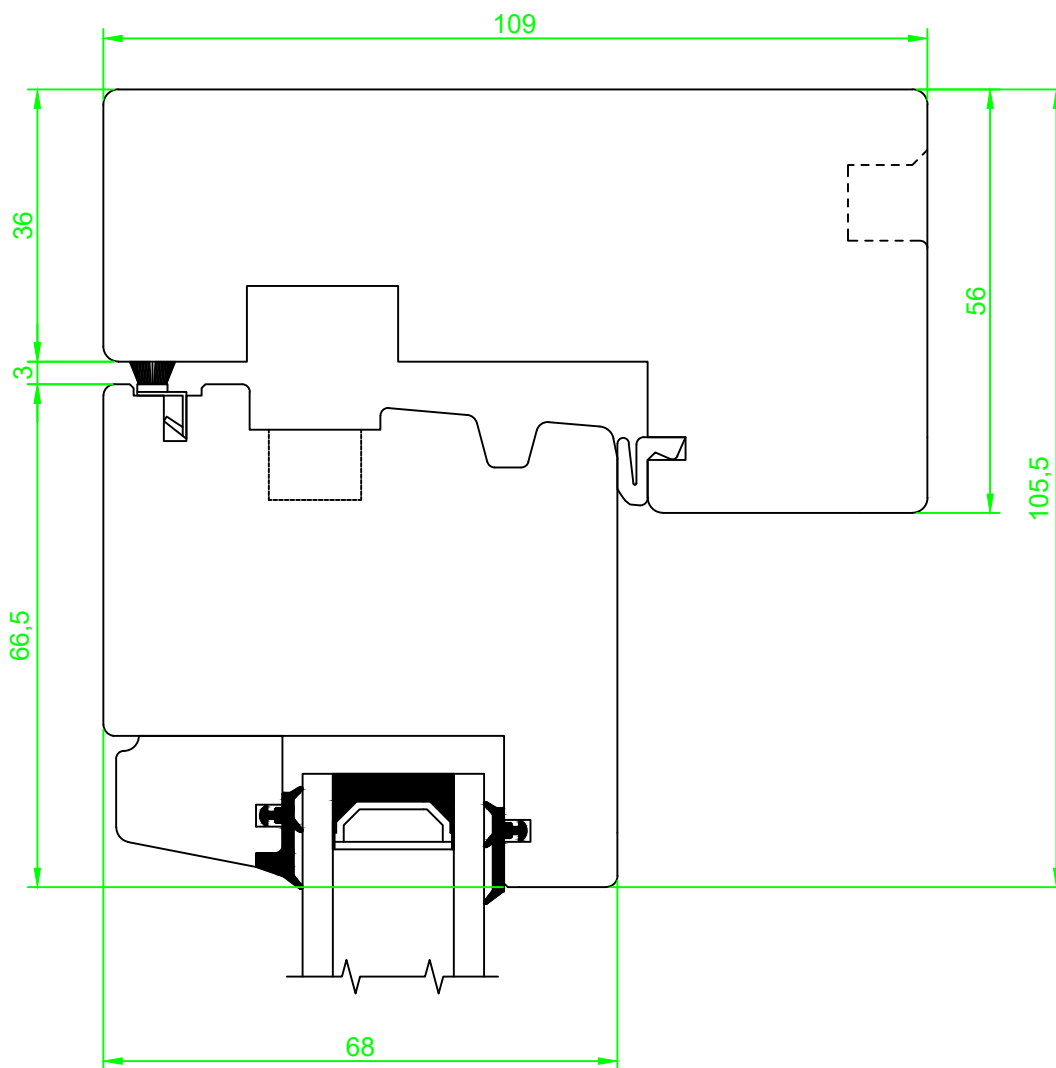

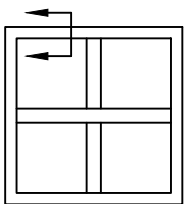

Date. 20.06.2014	Constr./draw. JA/EAO	Approved.	Scale. A4 1:1	Review nr. 5	Review date 28.02.2022
Sidehengslet vindu i tre med slepelist nede 109mm karm, 68mm ramme			Section: Vertikal	 Nordvestvinduet AS N-6713 ALMENNINGEN Tel +47 57 85 25 80 firmapost@nordvestvinduet.no www.nordvestvinduet.no	
			Part: Bunn		Drawing nr. VU_R68_G24_B
			Tolerance.: NS-ISO 2768-1-middels.	Design: Trend	



Date. 20.06.2014	Constr./draw. JA/EAO	Approved.	Scale. A4 1:1	Review nr. 4	Review date 26.09.2019
Sidehengslet vindu i tre 109mm karm, 68mm ramme			Section: Vertikal	 Nordvestvinduet AS N-6713 ALMENNINGEN Tel +47 57 85 25 80 firmapost@nordvestvinduet.no www.nordvestvinduet.no	
			Part: Topp		Drawing nr. VU_R68_G24_O
			Design: Trend		
Tolerance.: NS-ISO 2768-1-middels.					

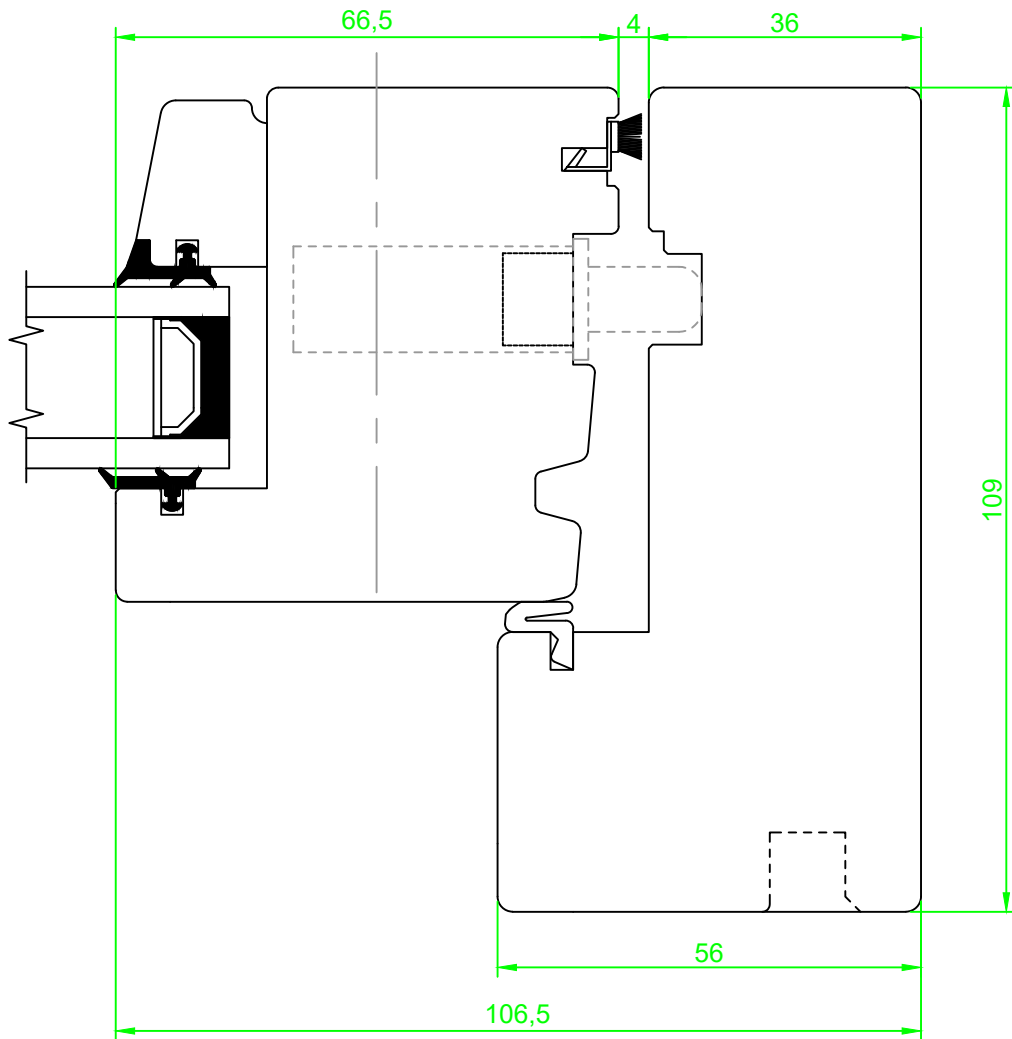
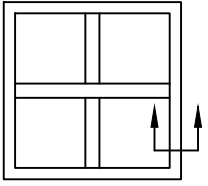

Date. 20.06.2014	Constr./draw. JA/EAO	Approved.	Scale. A4 1:1	Review nr. 4	Review date 26.09.2019
Sidehengslet vindu i tre 109mm karm, 68mm ramme			Section: Horisontal	 <small>Nordvestvinduet AS N-6713 ALMENNINGEN Tel +47 57 85 25 80 firmapost@nordvestvinduet.no www.nordvestvinduet.no</small>	
			Part: Side		Drawing nr. VU_R68_G24_LS
			Tolerance.: NS-ISO 2768-1-middels.	Design: Trend	

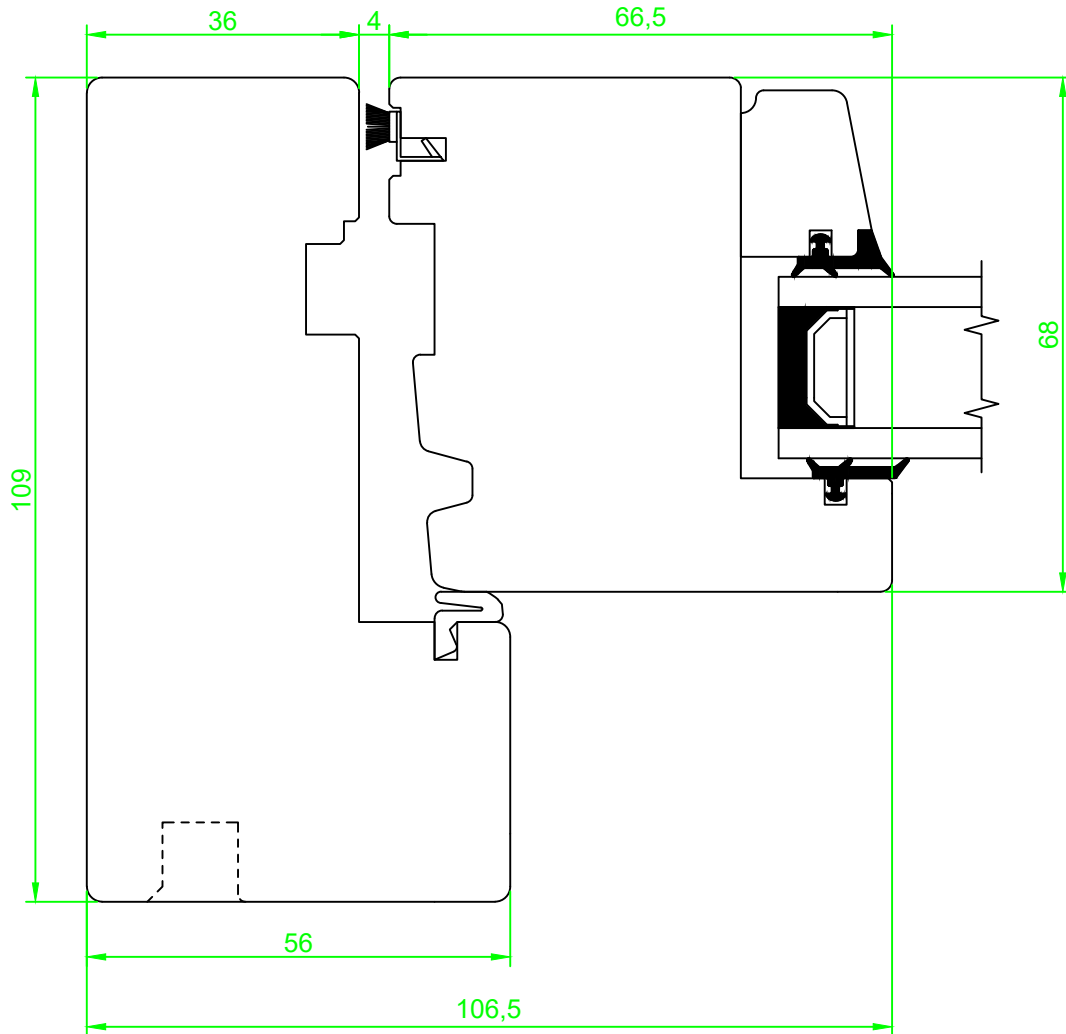
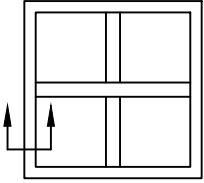

Date. 20.06.2014	Constr./draw. JA/EAO	Approved.	Scale. A4 1:1	Review nr. 4	Review date 26.09.2019
Sidehengslet vindu i tre 109mm karm, 68mm ramme			Section: Horizontal	 <small>Nordvestvinduet AS N-6713 ALMENNINGEN Tel +47 57 85 25 80 firmapost@nordvestvinduet.no www.nordvestvinduet.no</small>	
			Part: Side		Drawing nr. VU_R68_G24_HS
Tolerance.: NS-ISO 2768-1-middels.			Design: Trend		

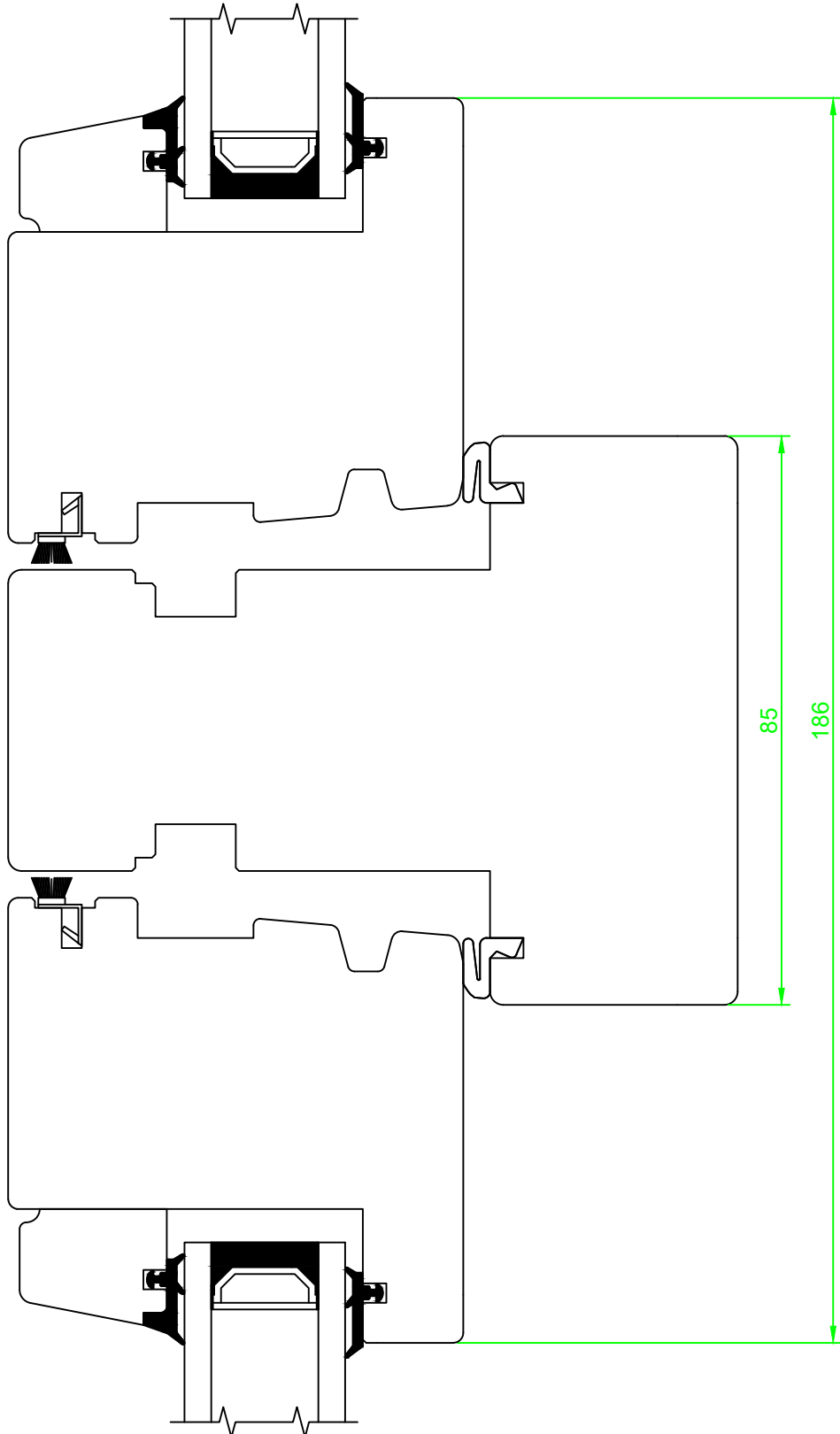
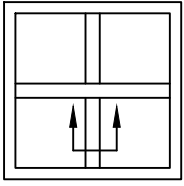

<i>Date.</i> 20.06.2014	<i>Constr./draw.</i> JA/EAO	<i>Approved.</i>	<i>Scale.</i> A4 1:1	<i>Review nr.</i> 4	<i>Review date</i> 26.09.2019
Sidehengslet vindu i tre 85mm post, 68mm ramme			<i>Section:</i> Horisontal	 Nordvestvinduet AS N-6713 ALMENNINGEN Tel +47 57 85 25 80 firmapost@nordvestvinduet.no www.nordvestvinduet.no	<i>Drawing nr.</i> VU_R68_G24_P85
			<i>Part:</i> Post		
			<i>Design:</i> Trend		
<i>Tolerance.:</i> NS-ISO 2768-1-middels.					

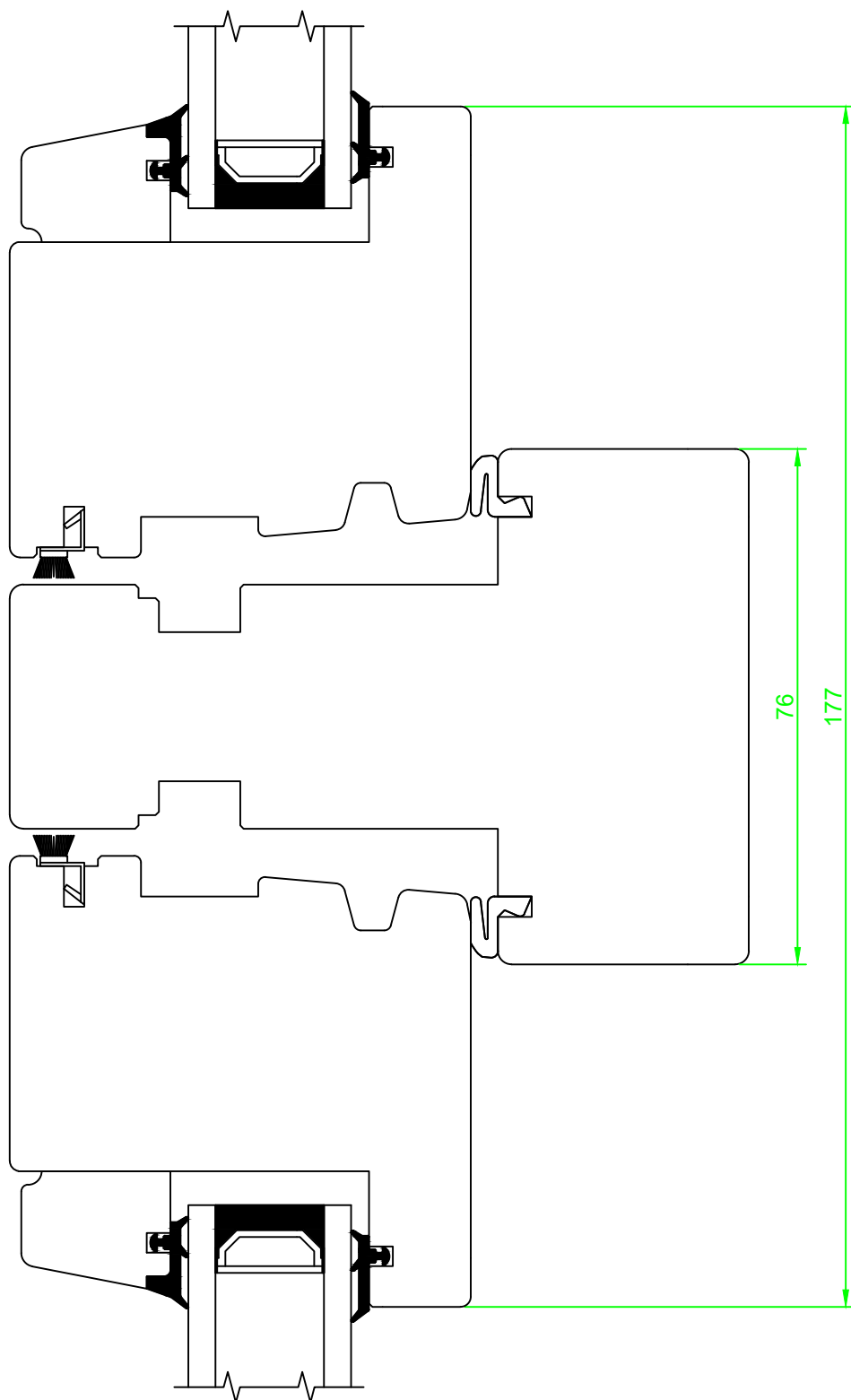
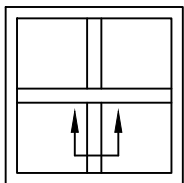

Date. 20.06.2014	Constr./draw. JA/EAO	Approved.	Scale. A4 1:1	Review nr. 4	Review date 26.09.2019
Sidehengslet vindu i tre 76mm post, 68mm ramme			Section: Horizontal		<small>Nordvestvinduet AS N-6713 ALMENNINGEN Tel +47 57 85 25 80 firmapost@nordvestvinduet.no www.nordvestvinduet.no</small>
			Part: Post		
			Tolerance.: NS-ISO 2768-1-middels.		

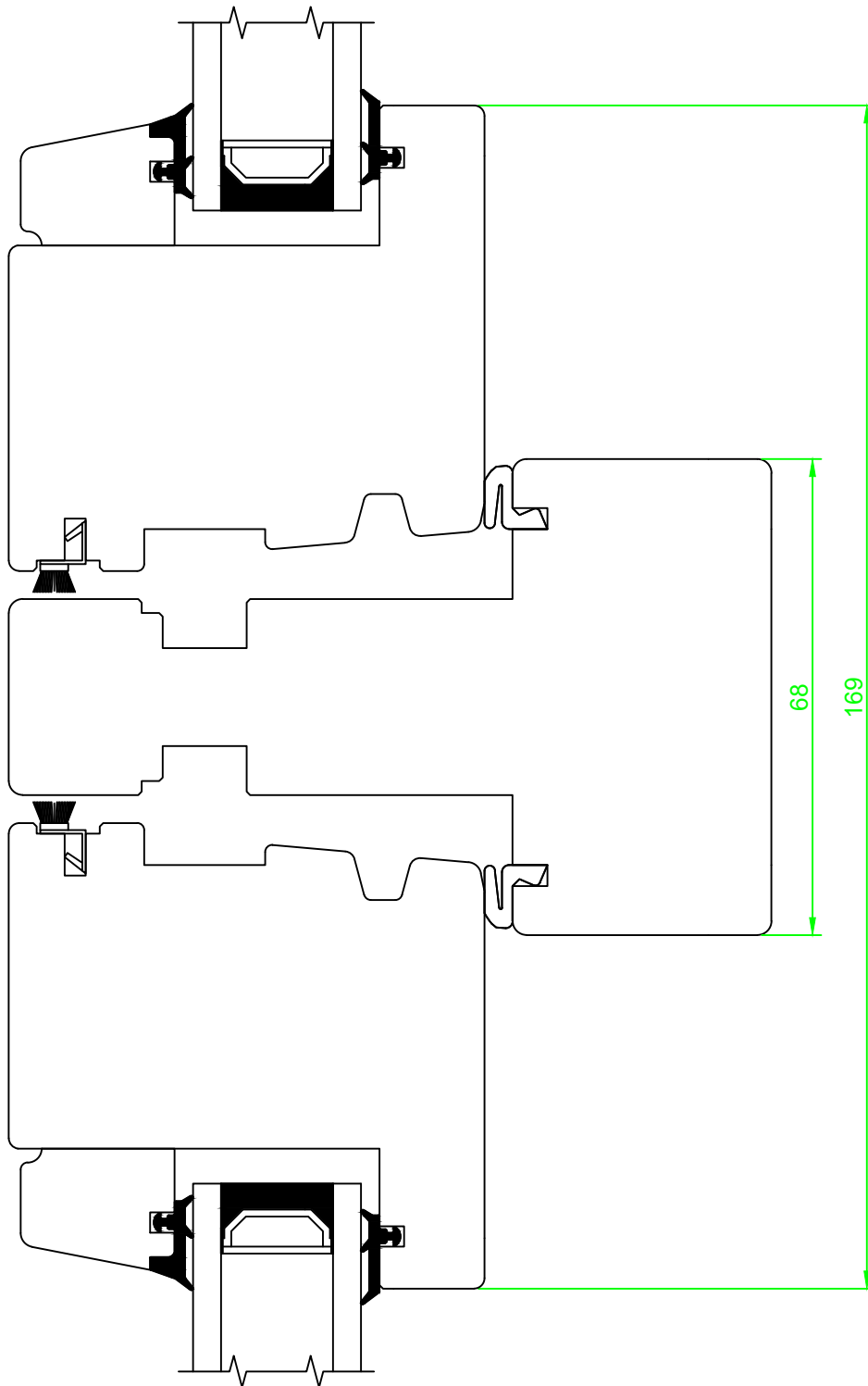
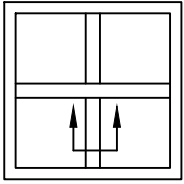

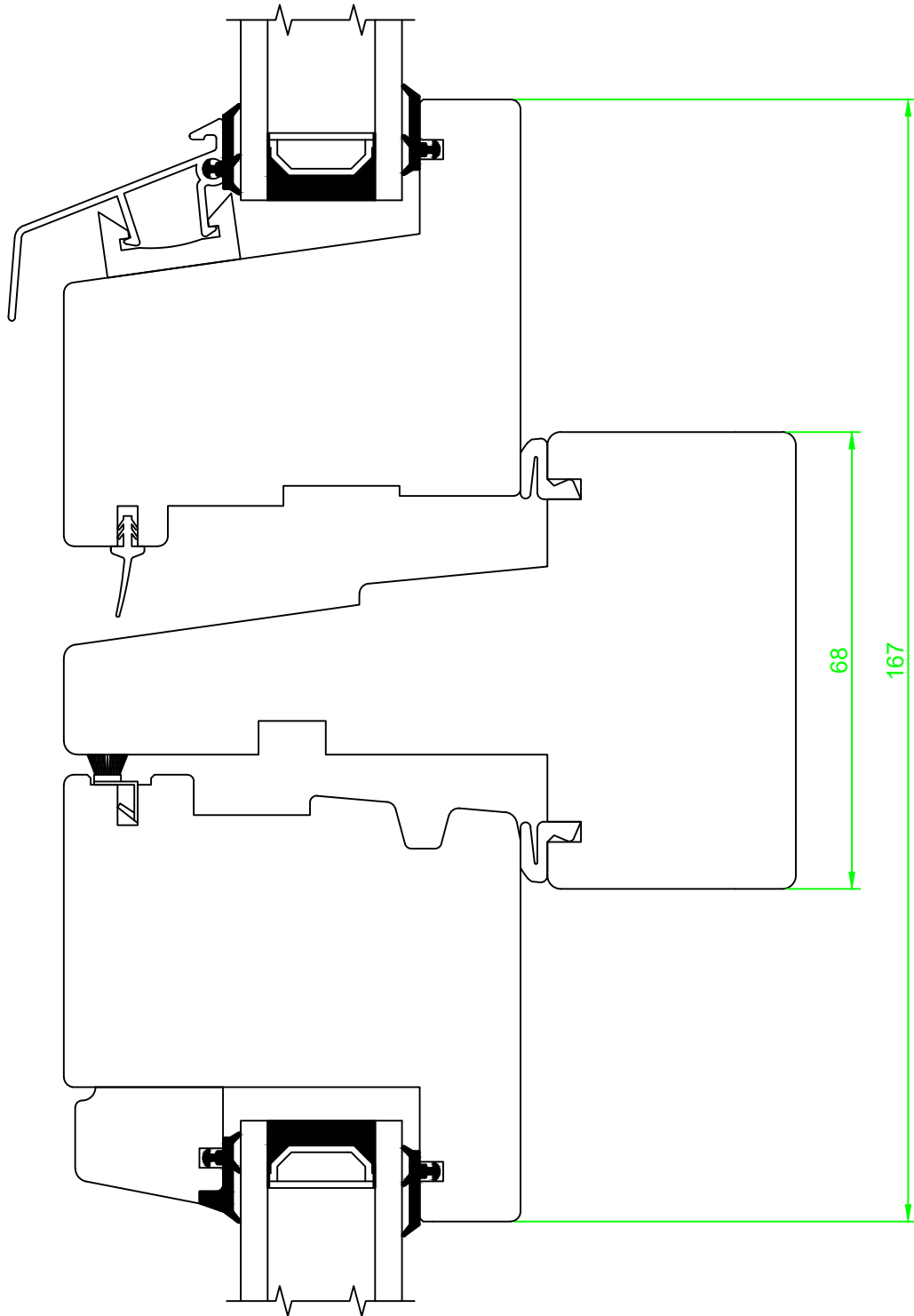
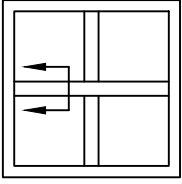

<i>Date.</i> 20.06.2014	<i>Constr./draw.</i> JA/EAO	<i>Approved.</i>	<i>Scale.</i> A4 1:1	<i>Review nr.</i> 4	<i>Review date</i> 26.09.2019
Sidehengslet vindu i tre 68mm post, 68mm ramme			<i>Section:</i> Horizontal	 <small>Nordvestvinduet AS N-6713 ALMENNINGEN Tel +47 57 85 25 80 firmapost@nordvestvinduet.no www.nordvestvinduet.no</small>	
			<i>Part:</i> Post		
<i>Tolerance.:</i> NS-ISO 2768-1-middels.			<i>Design:</i> Trend		



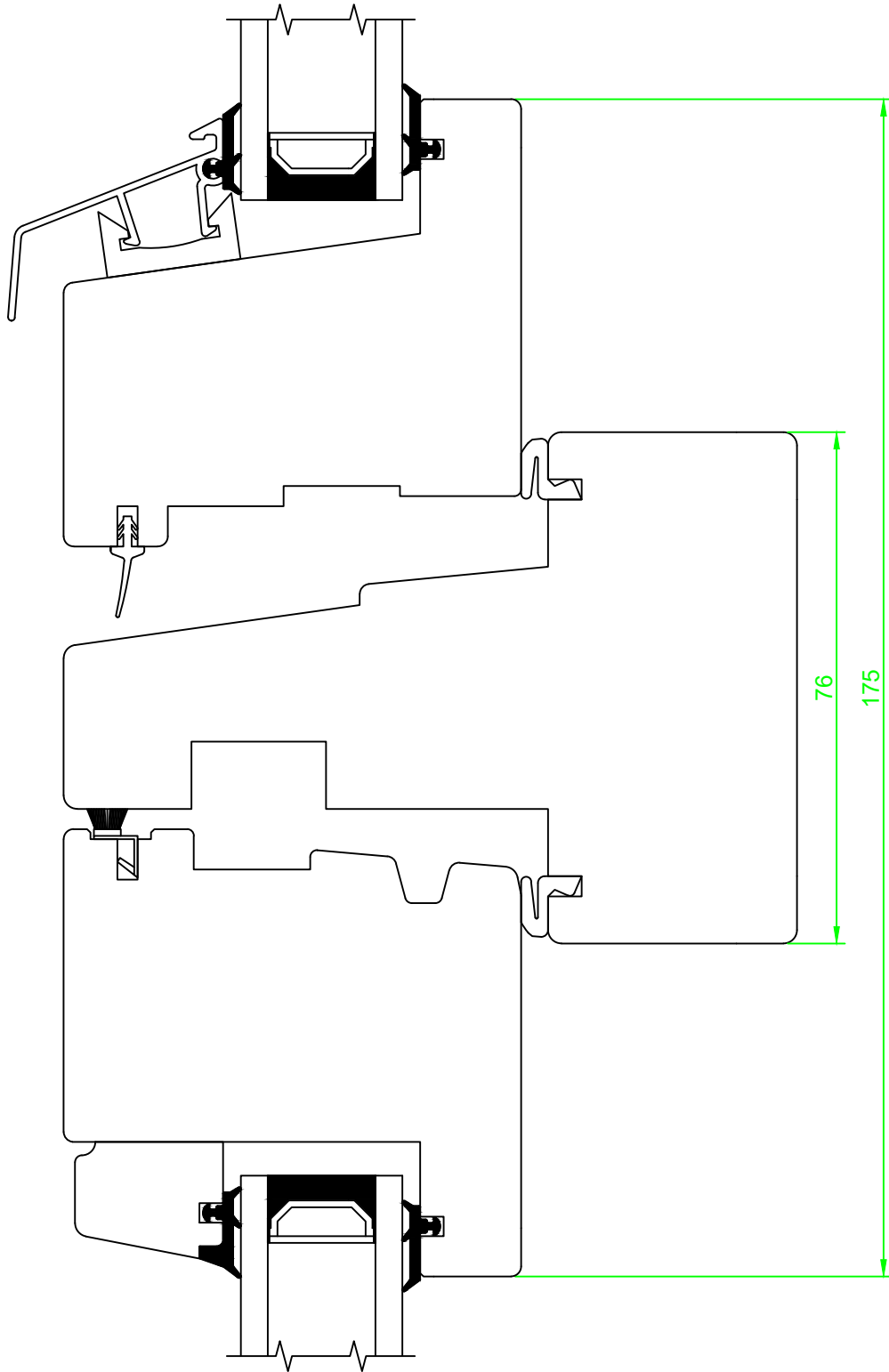
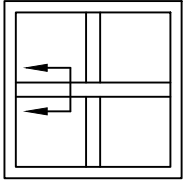

<i>Date.</i> 20.06.2014	<i>Constr./draw.</i> JA/EAO	<i>Approved.</i>	<i>Scale.</i> A4 1:1	<i>Review nr.</i> 4	<i>Review date</i> 26.09.2019
Sidehengslet vindu i tre 109x68 mm losholt, 68mm ramme			<i>Section:</i> Vertikal	 <small>Nordvestvinduet AS N-6713 ALMENNINGEN Tel +47 57 85 25 80 firmapost@nordvestvinduet.no www.nordvestvinduet.no</small>	
			<i>Part:</i> Losholt		
<i>Tolerance.:</i> NS-ISO 2768-1-middels.			<i>Design:</i> Trend		



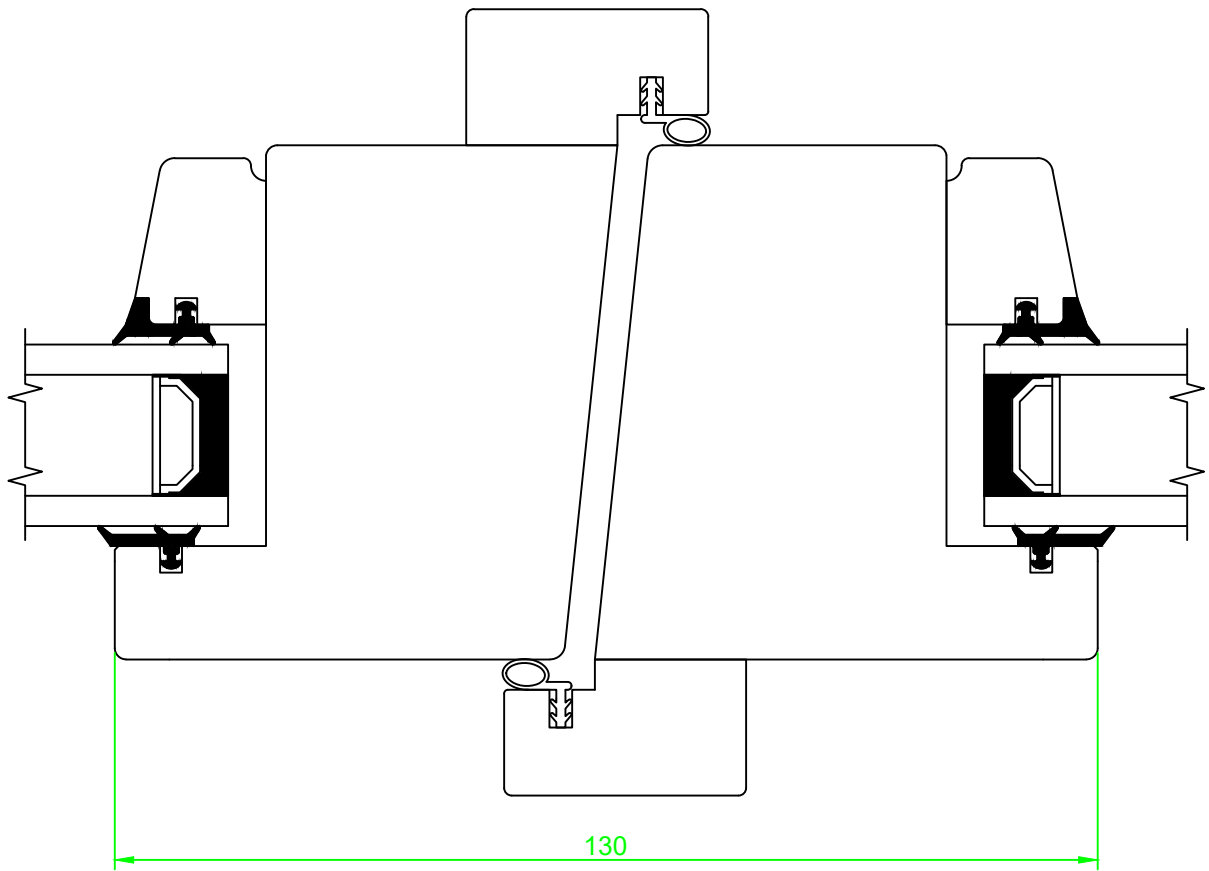
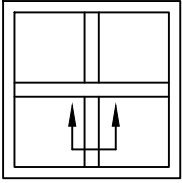

<i>Date.</i> 20.06.2014	<i>Constr./draw.</i> JA/EAO	<i>Approved.</i>	<i>Scale.</i> A4 1:1	<i>Review nr.</i> 4	<i>Review date</i> 26.09.2019
Sidehengslet vindu i tre 109x76 mm losholt, 68mm ramme			<i>Section:</i> Vertikal	 <small>Nordvestvinduet AS N-6713 ALMENNINGEN Tel +47 57 85 25 80 firmapost@nordvestvinduet.no www.nordvestvinduet.no</small>	
			<i>Part:</i> Losholt		<i>Drawing nr.</i> VU_R68_G24_L76
<i>Tolerance.:</i> NS-ISO 2768-1-middels.			<i>Design:</i> Trend		



<i>Date.</i> 11.03.2009	<i>Constr./draw.</i> JA/EAO	<i>Approved.</i>	<i>Scale.</i> A4 1:1	<i>Review nr.</i> 4	<i>Review date</i> 26.09.2019	
Sidehengslet vindu i tre 68mm ramme, tofløyet			<i>Section:</i> Horisontal	 <small>Nordvestvinduet AS N-6713 ALMENNINGEN Tel +47 57 85 25 80 firmapost@nordvestvinduet.no www.nordvestvinduet.no</small>		
			<i>Part:</i> Stulp			<i>Drawing nr.</i> VU_R68_G24_ST
			<i>Design:</i> Trend			
<i>Tolerance.:</i> NS-ISO 2768-1-middels.						