

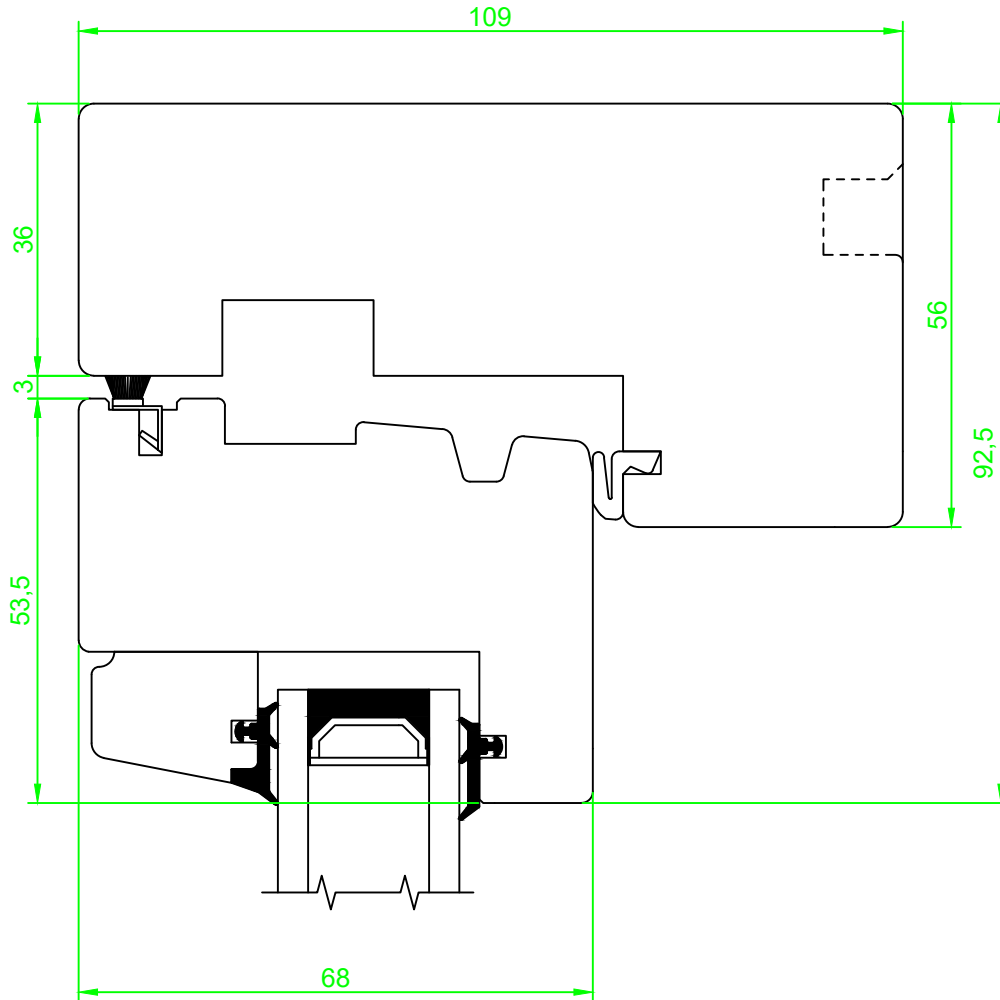

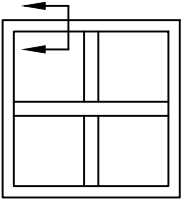

<i>Date.</i> 20.06.2014	<i>Constr./draw.</i> JA/EAO	<i>Approved.</i>	<i>Scale.</i> A4 1:1	<i>Review nr.</i> 5	<i>Review date</i> 28.02.2022
Sidehengslet utadslående vindu 109mm karm, 55mm ramme			<i>Section:</i> Vertikal	 <small>Nordvestvinduet AS N-6713 ALMENNINGEN Tel +47 57 85 25 80 firmapost@nordvestvinduet.no www.nordvestvinduet.no</small>	
			<i>Part:</i> Bunn		
			<i>Tolerance.:</i> NS-ISO 2768-1-middels.	<i>Design:</i> Trend	



Date. 20.06.2014	Constr./draw. JA/EAO	Approved.	Scale. A4 1:1	Review nr. 4	Review date 24.09.2019
Sidehengslet utadslående vindu 109mm karm, 55mm ramme			Section: Vertikal	 <small>Nordvestvinduet AS N-6713 ALMENNINGEN Tel +47 57 85 25 80 firmapost@nordvestvinduet.no www.nordvestvinduet.no</small>	
			Part: Topp		
			Tolerance.: NS-ISO 2768-1-middels.	Design: Trend	

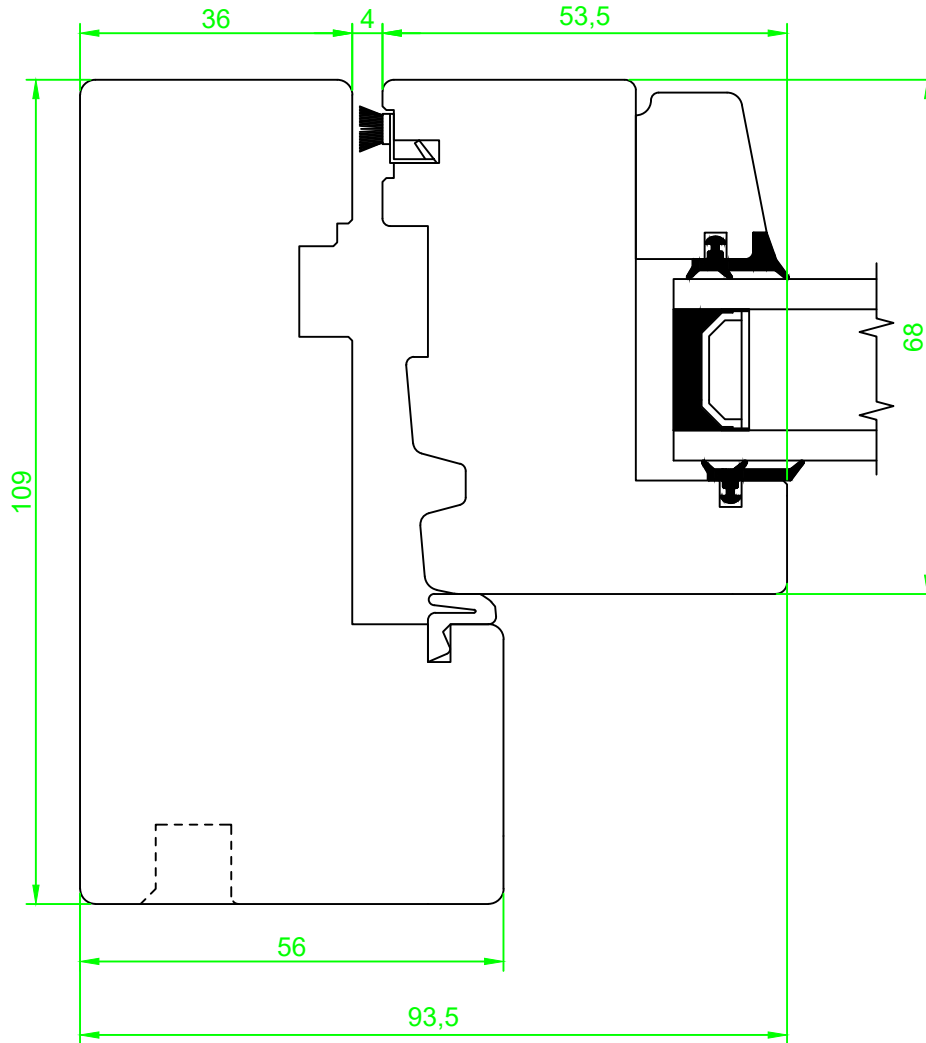
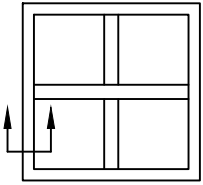

<i>Date.</i> 20.06.2014	<i>Constr./draw.</i> JA/EAO	<i>Approved.</i>	<i>Scale.</i> A4 1:1	<i>Review nr.</i> 4	<i>Review date</i> 24.09.2019
Sidehengslet utadslående vindu 109mm karm, 55mm ramme			<i>Section:</i> Horizontal	 <small>Nordvestvinduet AS N-6713 ALMENNINGEN Tlf: +47 57 95 25 90 firmapost@nordvestvinduet.no www.nordvestvinduet.no</small>	
			<i>Part:</i> Side		<i>Drawing nr.</i> VU_R55_G24_HS
			<i>Tolerance.:</i> NS-ISO 2768-1-middels.	<i>Design:</i> Trend	

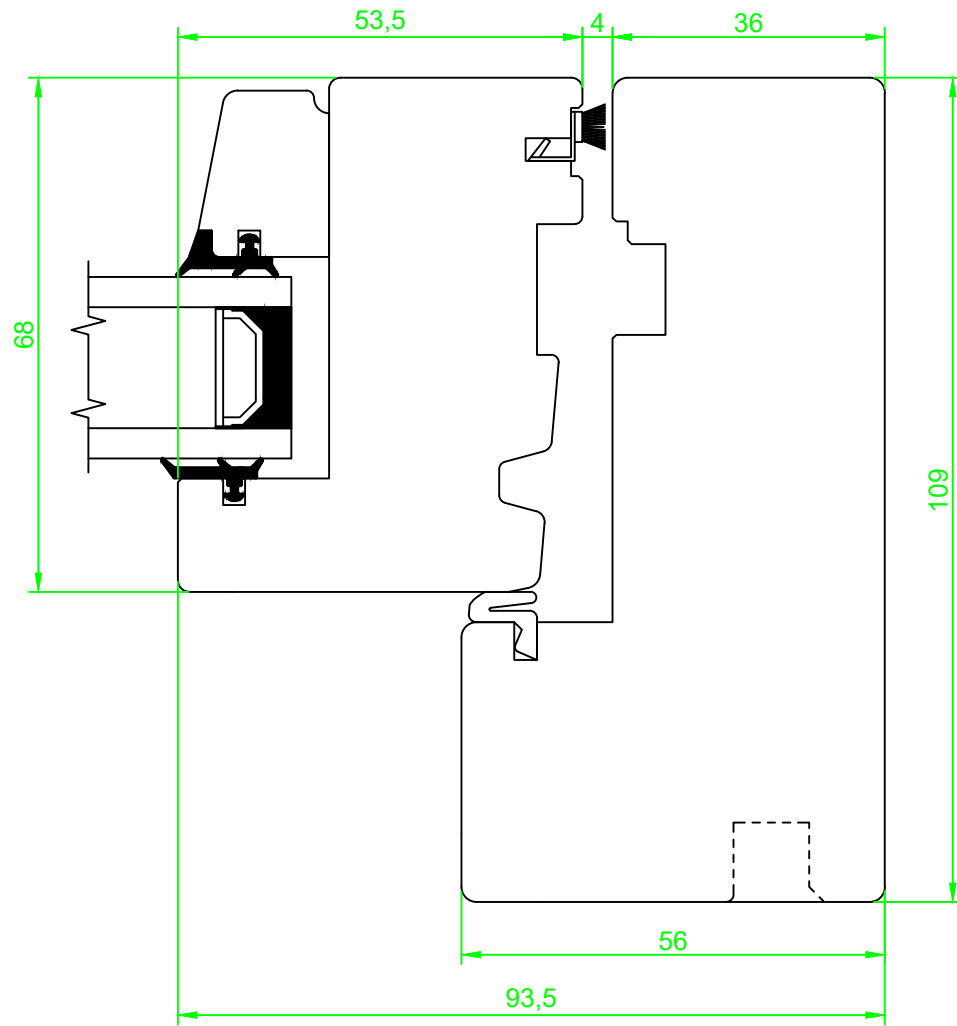
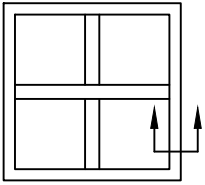

Date. 20.06.2014	Constr./draw. JA/EAO	Approved.	Scale. A4 1:1	Review nr. 4	Review date 24.09.2019
Sidehengslet utadslående vindu 109mm karm, 55mm ramme			Section: Horizontal	 <small>Nordvestvinduet AS N-6713 ALMENNINGEN Tel +47 57 85 25 80 firmapost@nordvestvinduet.no www.nordvestvinduet.no</small>	
			Part: Side		
Tolerance.: NS-ISO 2768-1-middels.			Design: Trend		

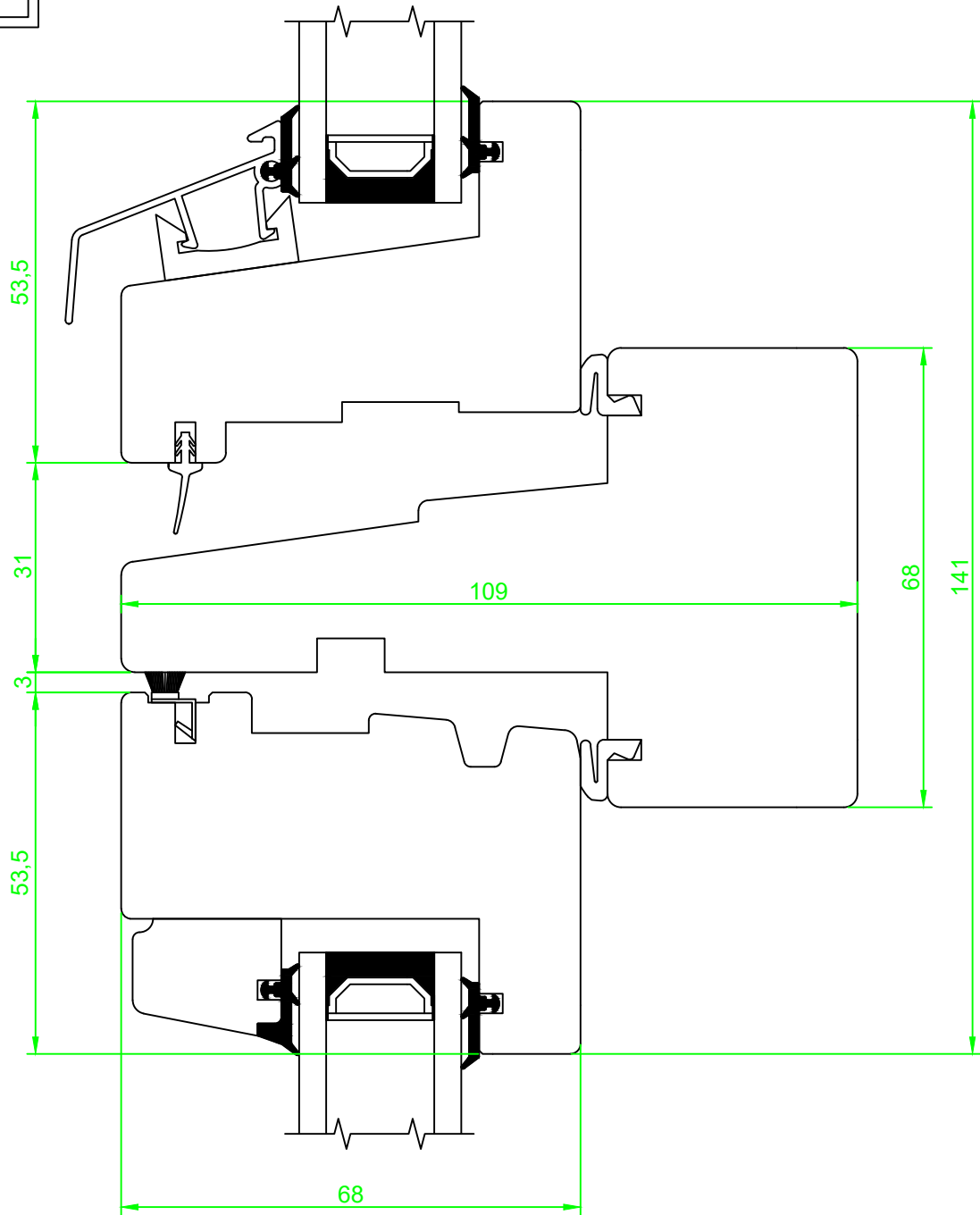
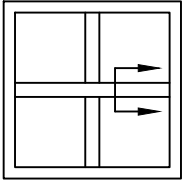

Date. 20.06.2014	Constr./draw. JA/EAO	Approved.	Scale. A4 1:1	Review nr. 4	Review date 24.09.2019
Sidehengslet utadslående vindu 109x68mm losholt, 55mm ramme			Section: Vertikal	 Nordvestvinduet AS N-8713 ALMENNINGEN Tel +47 57 85 25 80 firmapost@nordvestvinduet.no www.nordvestvinduet.no	
			Part: Losholt		Drawing nr. VU_R55_G24_L68
			Tolerance.: NS-ISO 2768-1-middels.	Design: Trend	

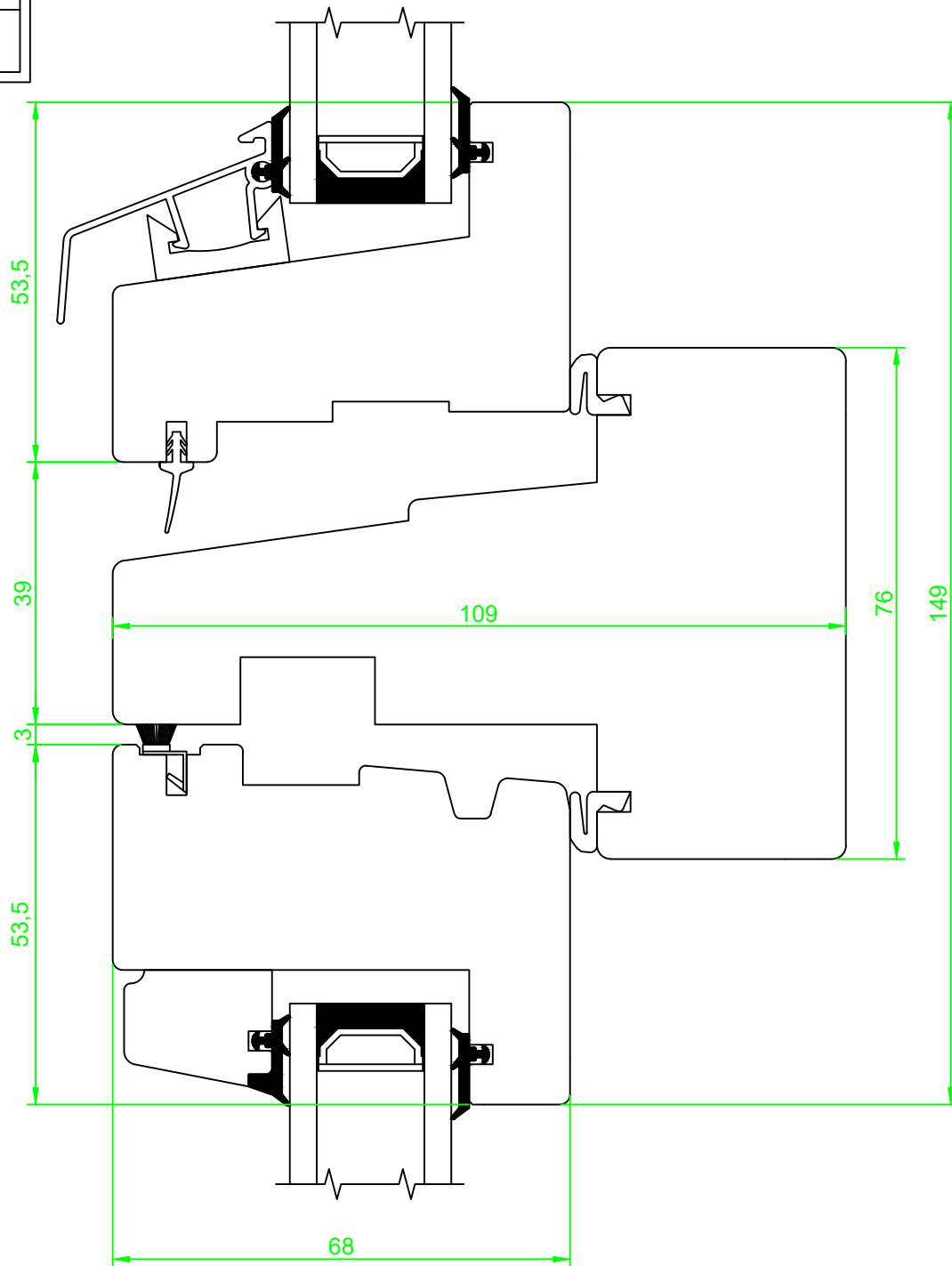
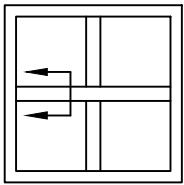

Date. 20.06.2014	Constr./draw. JA/EAO	Approved.	Scale. A4 1:1	Review nr. 4	Review date 24.09.2019
Sidehengslet utadslående vindu 109x76mm losholt, 55mm ramme			Section: Vertikal	 <small>Nordvestvinduet AS N-6713 ALMENNINGEN Tel +47 57 85 25 80 firmapost@nordvestvinduet.no www.nordvestvinduet.no</small>	
			Part: Losholt		
			Tolerance.: NS-ISO 2768-1-middels.	Design: Trend	

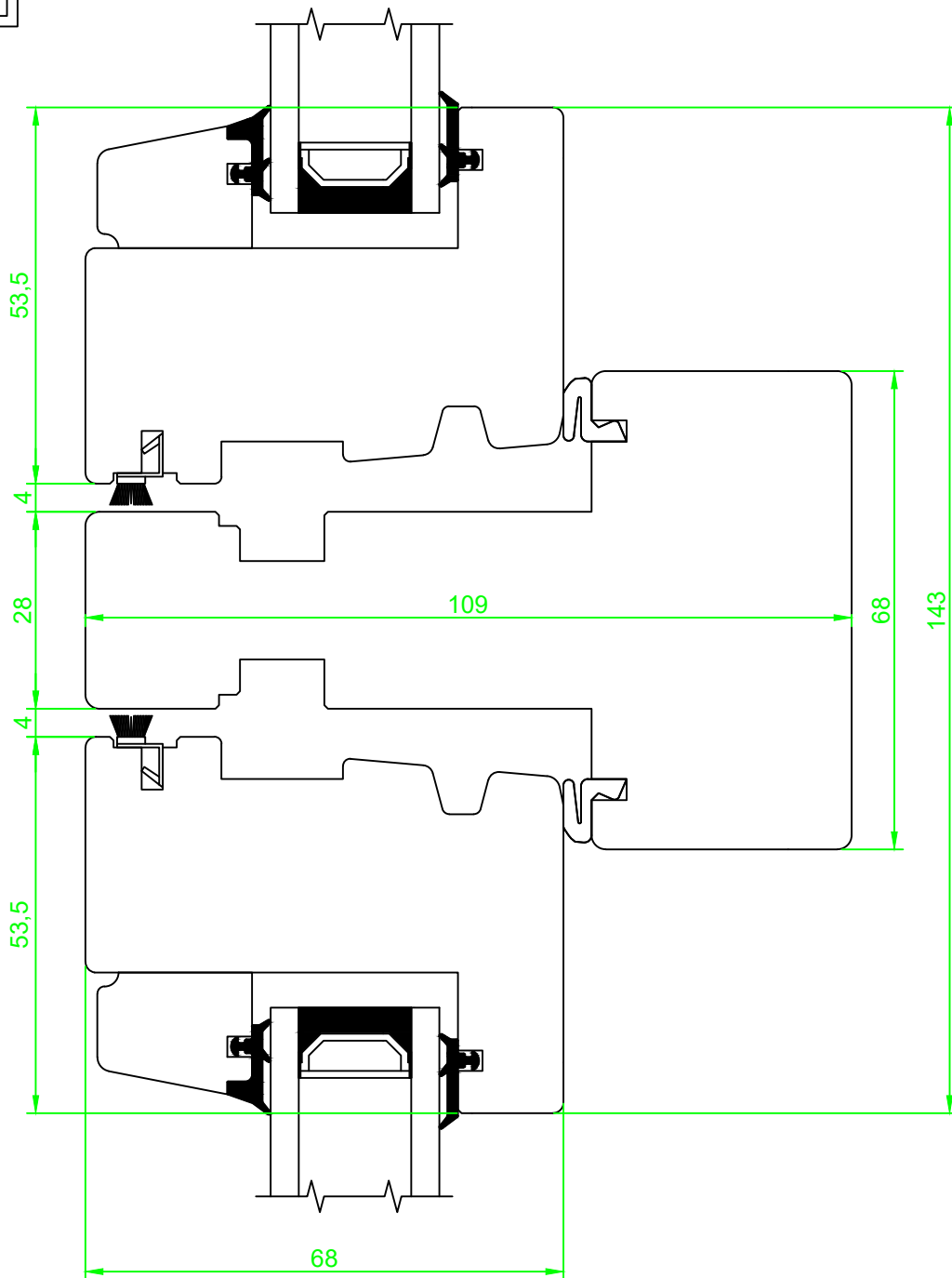
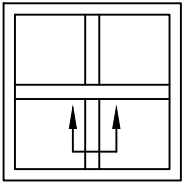

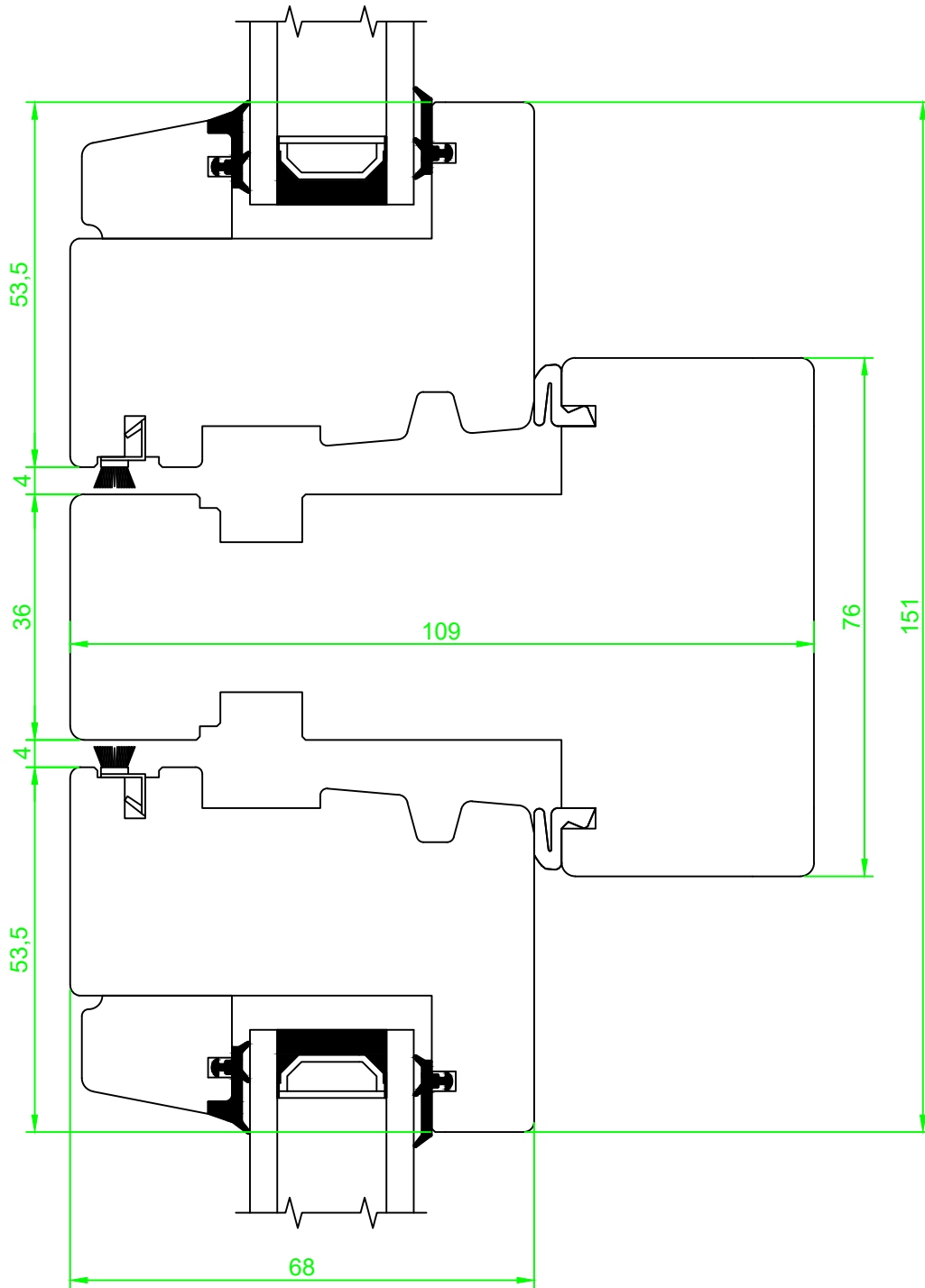
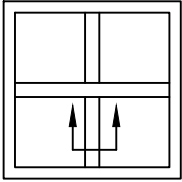

Date. 20.06.2014	Constr./draw. JA/EAO	Approved.	Scale. A4 1:1	Review nr. 4	Review date 24.09.2019
Sidehengslet utadslående vindu 109x68mm post, 55mm ramme			Section: Horizontal		<small>Nordvestvinduet AS N-6713 ALMENNINGEN Tel +47 57 95 25 90 firmapost@nordvestvinduet.no www.nordvestvinduet.no</small>
			Part: Post		
			Tolerance.: NS-ISO 2768-1-middels.	Design: Trend	



Date. 20.06.2014	Constr./draw. JA/EAO	Approved.	Scale. A4 1:1	Review nr. 4	Review date 24.09.2019
Sidehengslet utadslående vindu 109x76mm post, 55mm ramme			Section: Horizontal	 Nordvestvinduet AS N-6713 ALMENNINGEN Tel +47 57 85 25 80 firmapost@nordvestvinduet.no www.nordvestvinduet.no	
			Part: Post		Drawing nr. VU_R55_G24_P76
			Design: Trend		
Tolerance.: NS-ISO 2768-1-middels.					

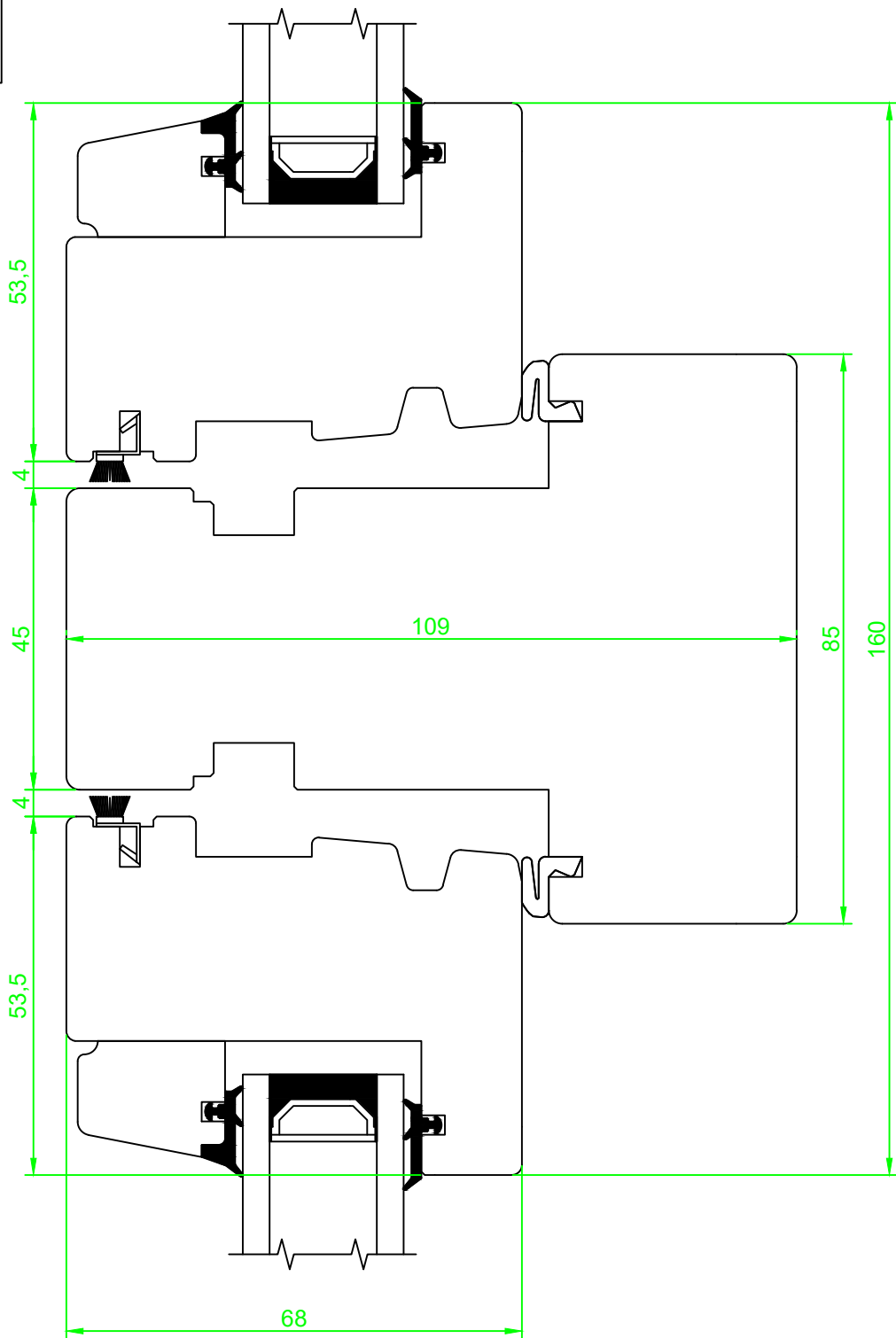
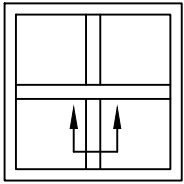



Date. 20.06.2014	Constr./draw. JA/EAO	Approved.	Scale. A4 1:1	Review nr. 4	Review date 24.09.2019	
Sidehengslet utadslående vindu 109x85mm post, 55mm ramme			Section: Horizontal	 <small>Nordvestvinduet AS N-6713 AL MENNINGEN Tel +47 57 85 25 80 firmapost@nordvestvinduet.no www.nordvestvinduet.no</small>		
			Part: Post			Drawing nr. VU_R55_G24_P85
			Design: Trend			
Tolerance.: NS-ISO 2768-1-middels.						