

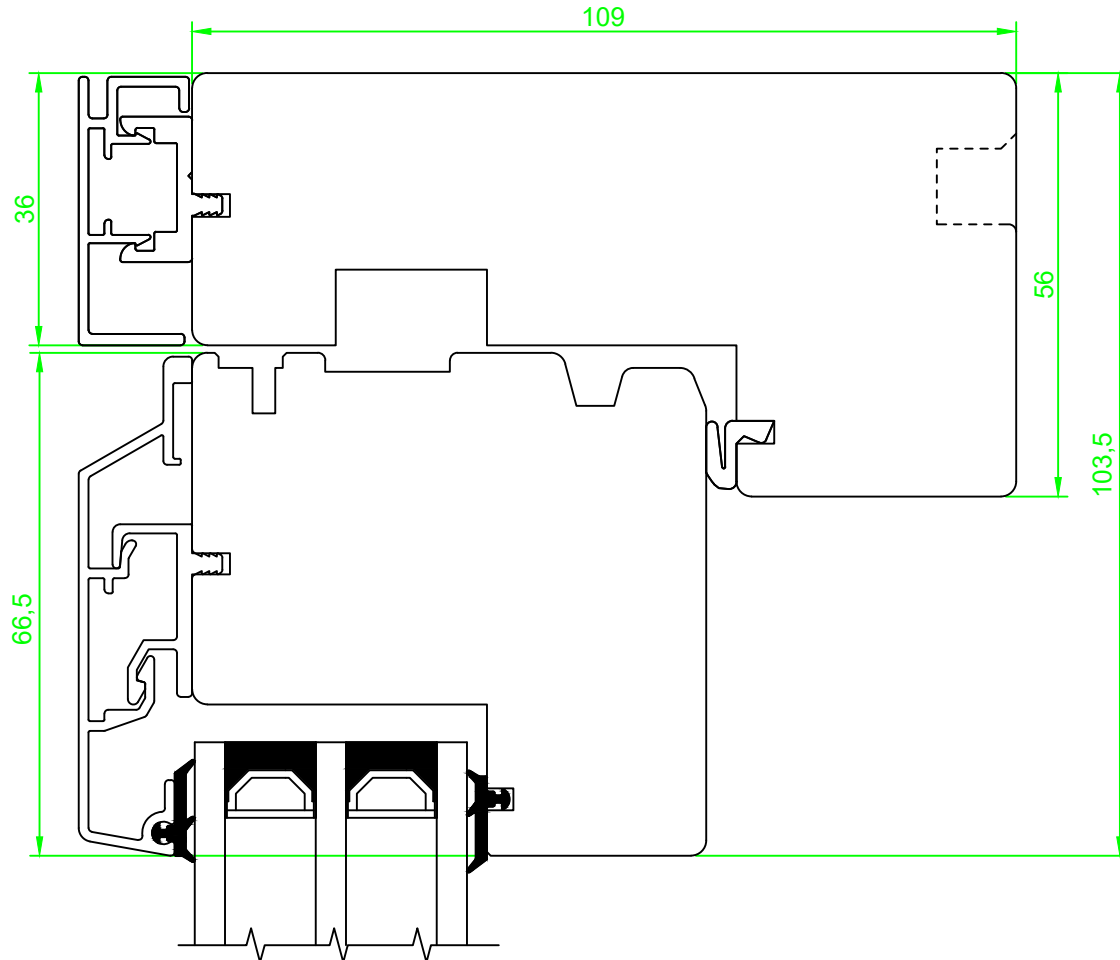

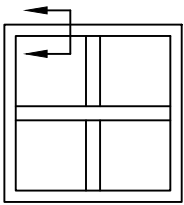

Date. 20.11.2018	Constr./draw. EAO	Approved.	Scale. A4 1:1	Review nr. 2	Review date 25.02.2022
Toppsvingvindu (VUTA), ramme 68mm			Section: Vertikal		<small>Nordvestvinduet AS N-6713 ALMENNINGEN Tel: +47 57 85 25 80 firmapost@nordvestvinduet.no www.nordvestvinduet.no</small>
			Part: Bunn		
Tolerance.: NS-ISO 2768-1-middels.			Design: Trend		



Date. 20.11.2018	Constr./draw. EAO	Approved.	Scale. A4 1:1	Review nr. 1	Review date 20.11.2018	
Toppsvingindu (VUTA), ramme 68mm			Section: Vertikal		<small>Nordvestvinduet AS N-6713 ALMENNINGEN Tel +47 57 85 25 80 firmapost@nordvestvinduet.no www.nordvestvinduet.no</small>	
			Part: Topp			Drawing nr. VUTA_TR_R68_G36_O
			Design: Trend			
Tolerance.: NS-ISO 2768-1-middels.						

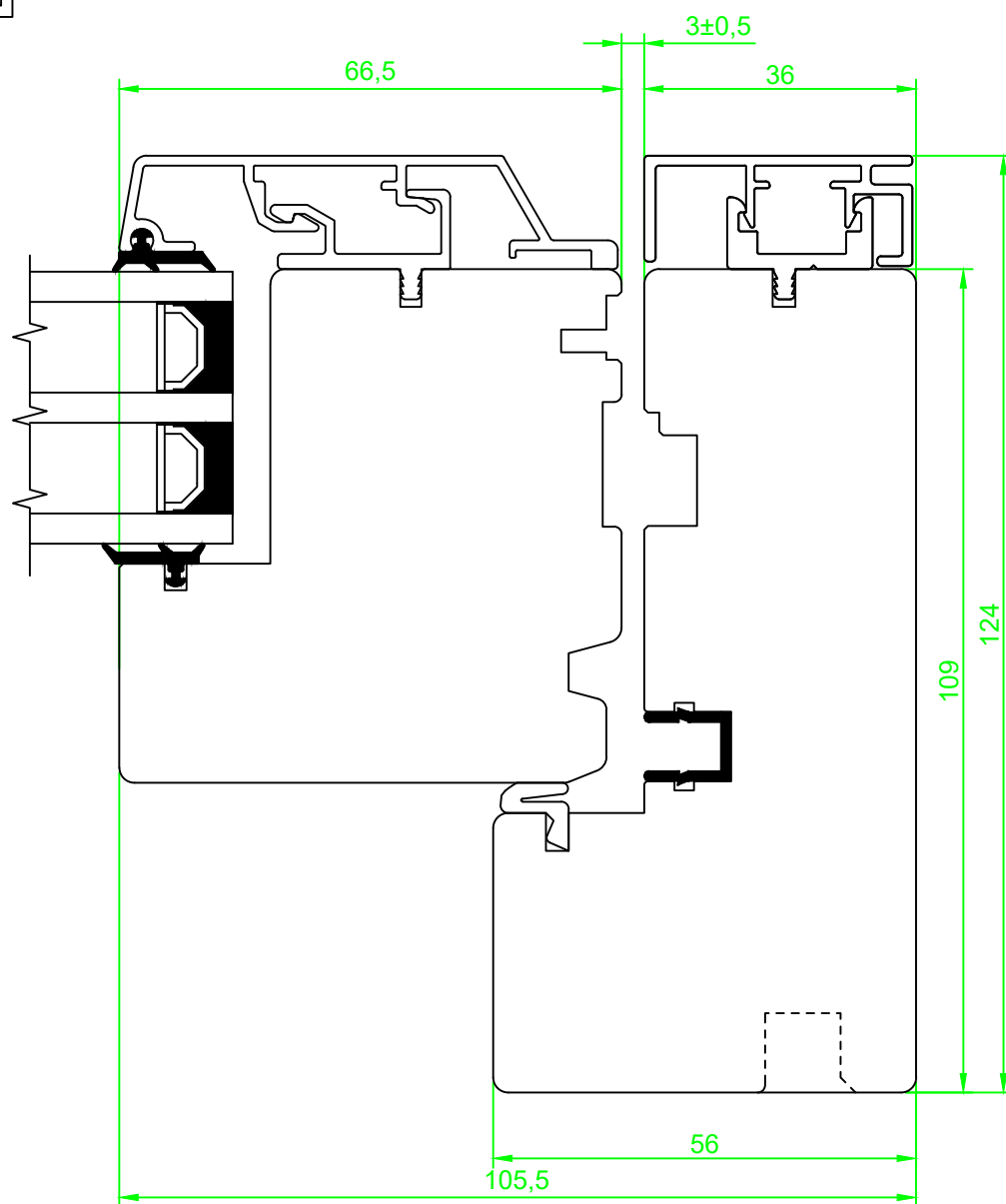
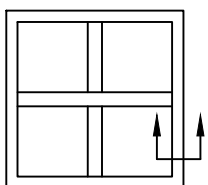

Date. 20.11.2018	Constr./draw. EAO	Approved.	Scale. A4 1:1	Review nr. 1	Review date 20.11.2018
Toppsvingvindu (VUTA), ramme 68mm			Section: Horizontal		<small>Nordvestvinduet AS N-6713 ALMENNINGEN Tel +47 57 85 25 80 firmapost@nordvestvinduet.no www.nordvestvinduet.no</small>
			Part: Side		
			Tolerance.: NS-ISO 2768-1-middels.	Design: Trend	

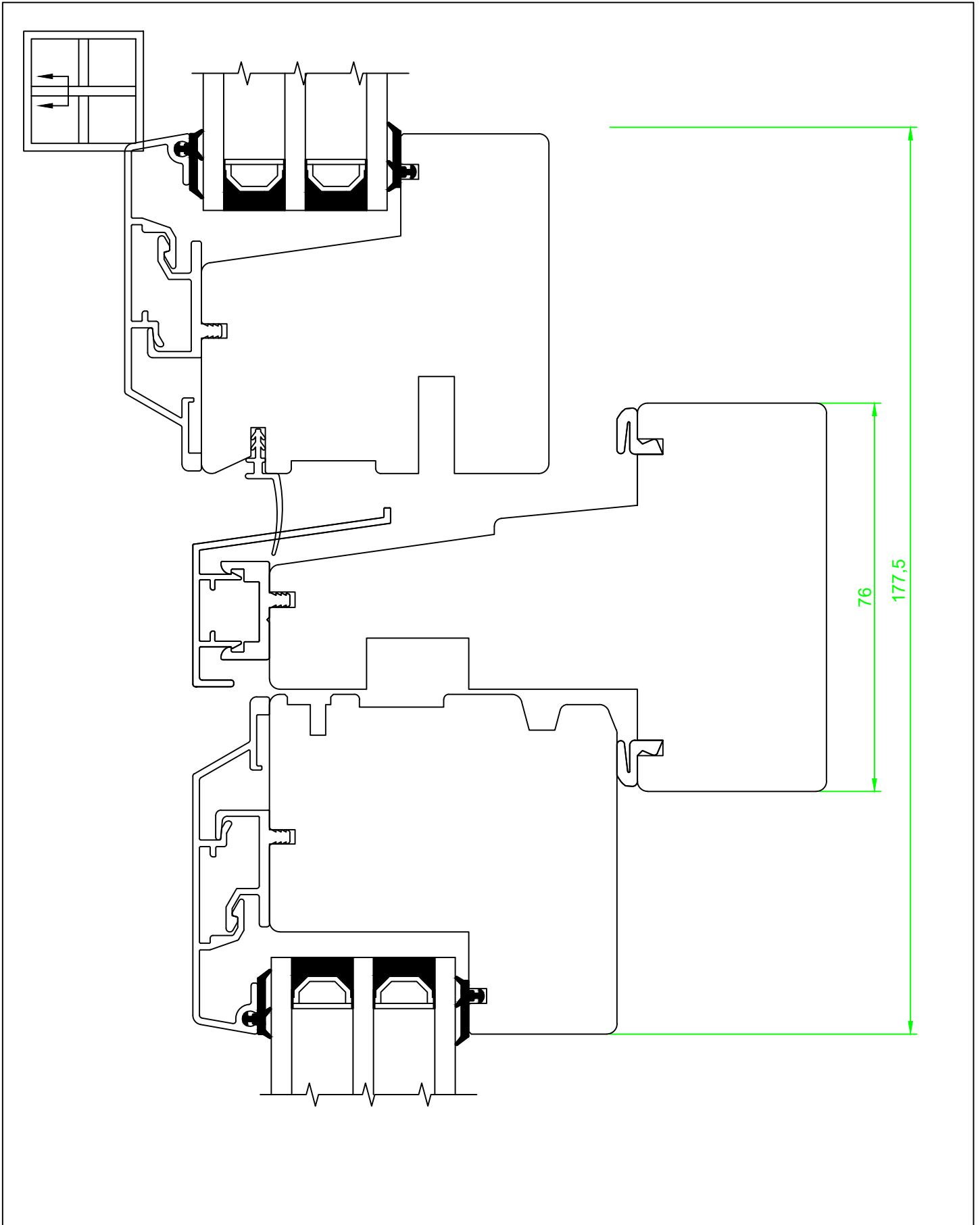

Date. 20.11.2018	Constr./draw. EAO	Approved.	Scale. A4 1:1	Review nr. 1	Review date 20.11.2018
Toppsvingvindu (VUTA), ramme 68mm, losholt 76mm			Section: Vertikal	 Nordvestvinduet AS N-8713 ALMIENNINGEN Tel +47 57 85 25 80 firmapost@nordvestvinduet.no www.nordvestvinduet.no	Drawing nr. VUTA_TR_R68_G36_L76
			Part: Losholt		
Tolerance.: NS-ISO 2768-1-middels.			Design: Trend		

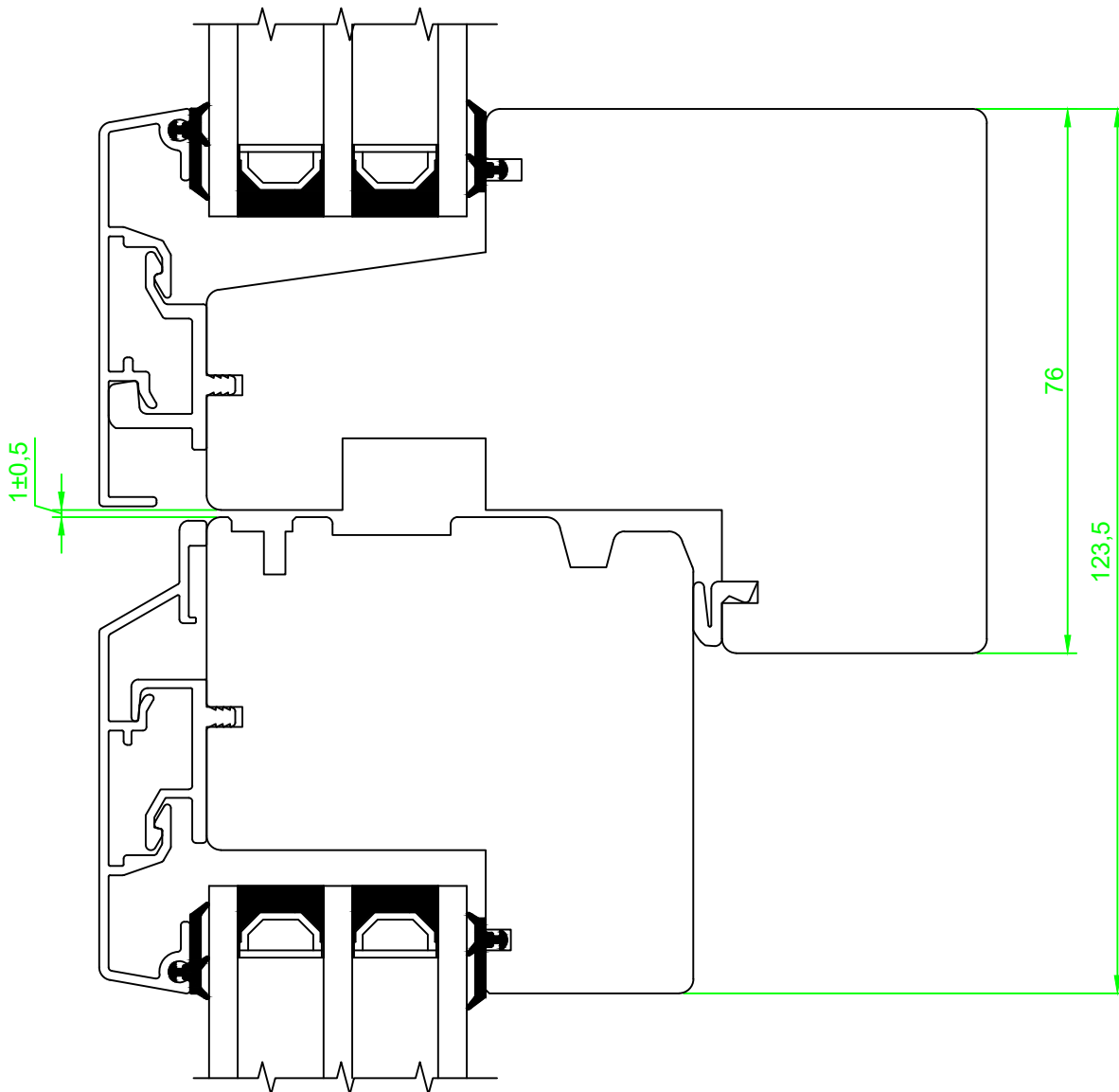
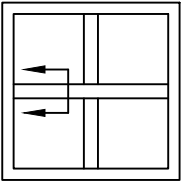

Date. 20.11.2018	Constr./draw. EAO	Approved.	Scale. A4 1:1	Review nr. 1	Review date 20.11.2018
Toppsvingvindu (VUTA), ramme 68mm, losholt 76mm			Section: Vertikal		<small>Nordvestvinduet AS N-6713 ALMENNINGEN Tel +47 57 85 25 80 firmapost@nordvestvinduet.no www.nordvestvinduet.no</small>
			Part: Losholt		
			Tolerance.: NS-ISO 2768-1-middels.		

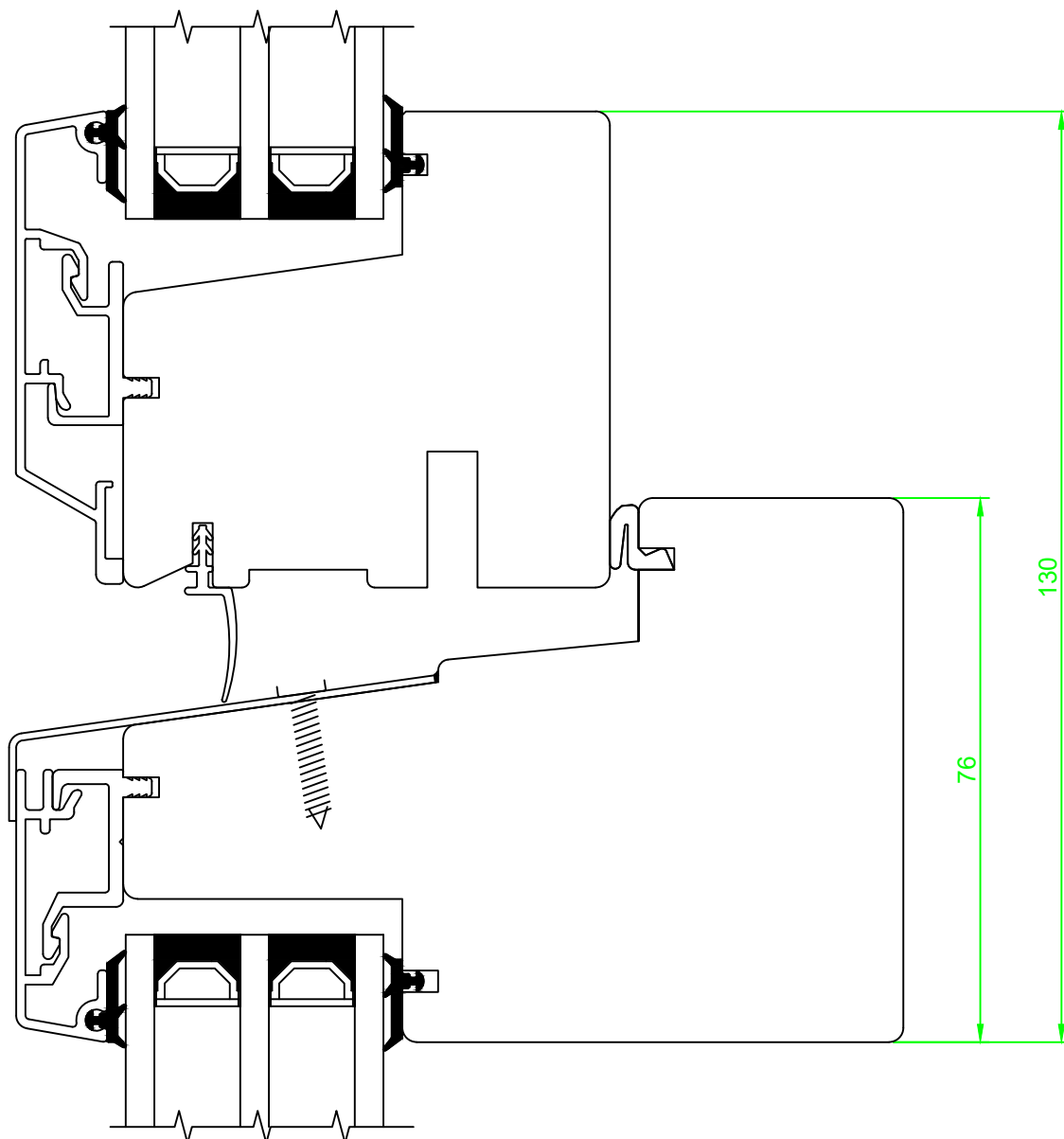
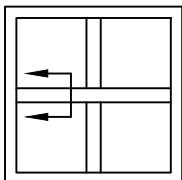

Date. 20.11.2018	Constr./draw. EAO	Approved.	Scale. A4 1:1	Review nr. 1	Review date 20.11.2018
Toppsvingvindu (VUTA), ramme 68mm, losholt 76mm			Section: Vertikal	 Nordvestvinduet AS N-6713 ALMENNINGEN Tel +47 57 85 25 80 firmapost@nordvestvinduet.no www.nordvestvinduet.no	
			Part: Losholt		Drawing nr. VUTA_TR_R68_G36_L76U
			Design: Trend		
Tolerance.: NS-ISO 2768-1-middels.					

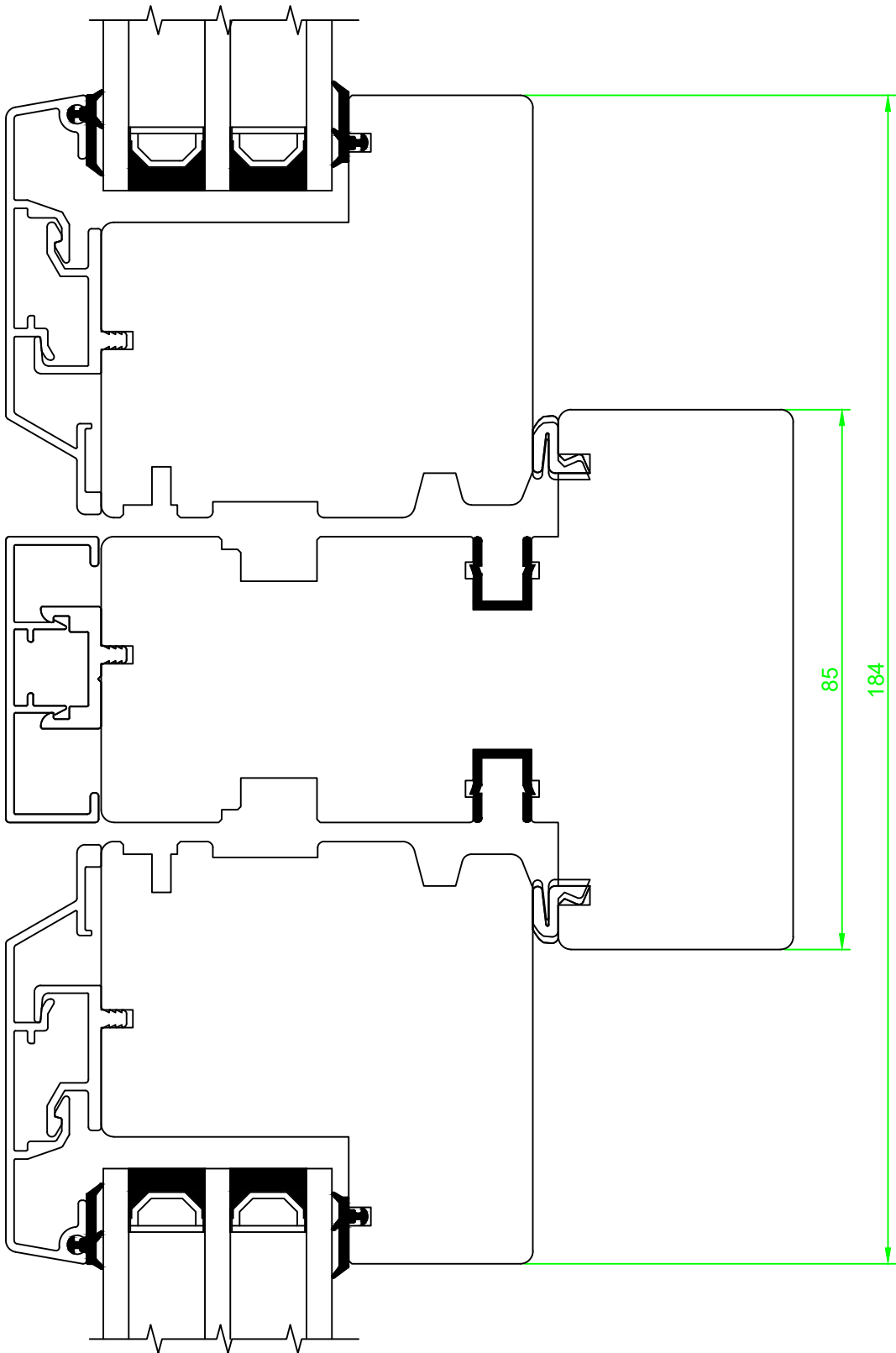
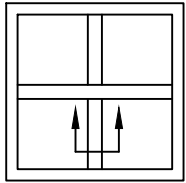

<i>Date.</i> 20.11.2018	<i>Constr./draw.</i> EAO	<i>Approved.</i>	<i>Scale.</i> A4 1:1	<i>Review nr.</i> 1	<i>Review date</i> 20.11.2018
Toppsvingvindu (VUTA), ramme 68mm, post 85mm			<i>Section:</i> Horizontal	 Nordvestvinduet AS N-6713 ALMENNINGEN Tel +47 57 85 25 80 firmapost@nordvestvinduet.no www.nordvestvinduet.no	<i>Drawing nr.</i> VUTA_TR_R68_G36_P85
			<i>Part:</i> Post		
<i>Tolerance.:</i> NS-ISO 2768-1-middels.			<i>Design:</i> Trend		

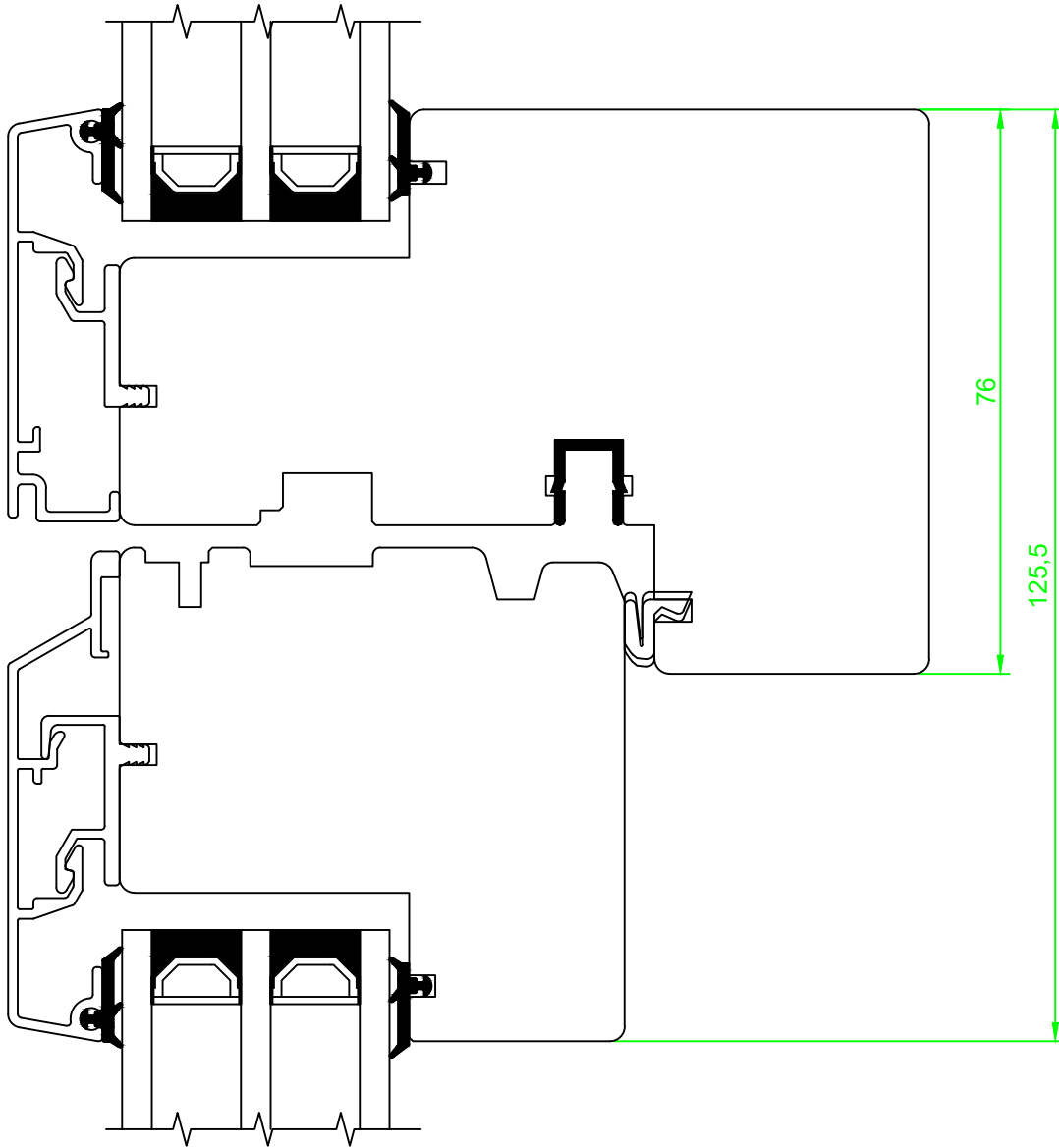
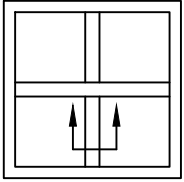

<i>Date.</i> 20.11.2018	<i>Constr./draw.</i> EAO	<i>Approved.</i>	<i>Scale.</i> A4 1:1	<i>Review nr.</i> 1	<i>Review date</i> 20.11.2018
Toppsvingvindu (VUTA), ramme 68mm, post 76mm			<i>Section:</i> Horizontal		<small>Nordvestvinduet AS N-6713 ALMENNINGSEN Tel +47 57 85 25 80 firmapost@nordvestvinduet.no www.nordvestvinduet.no</small>
			<i>Part:</i> Post		
<i>Tolerance.:</i> NS-ISO 2768-1-middels.			<i>Design:</i> Trend		