

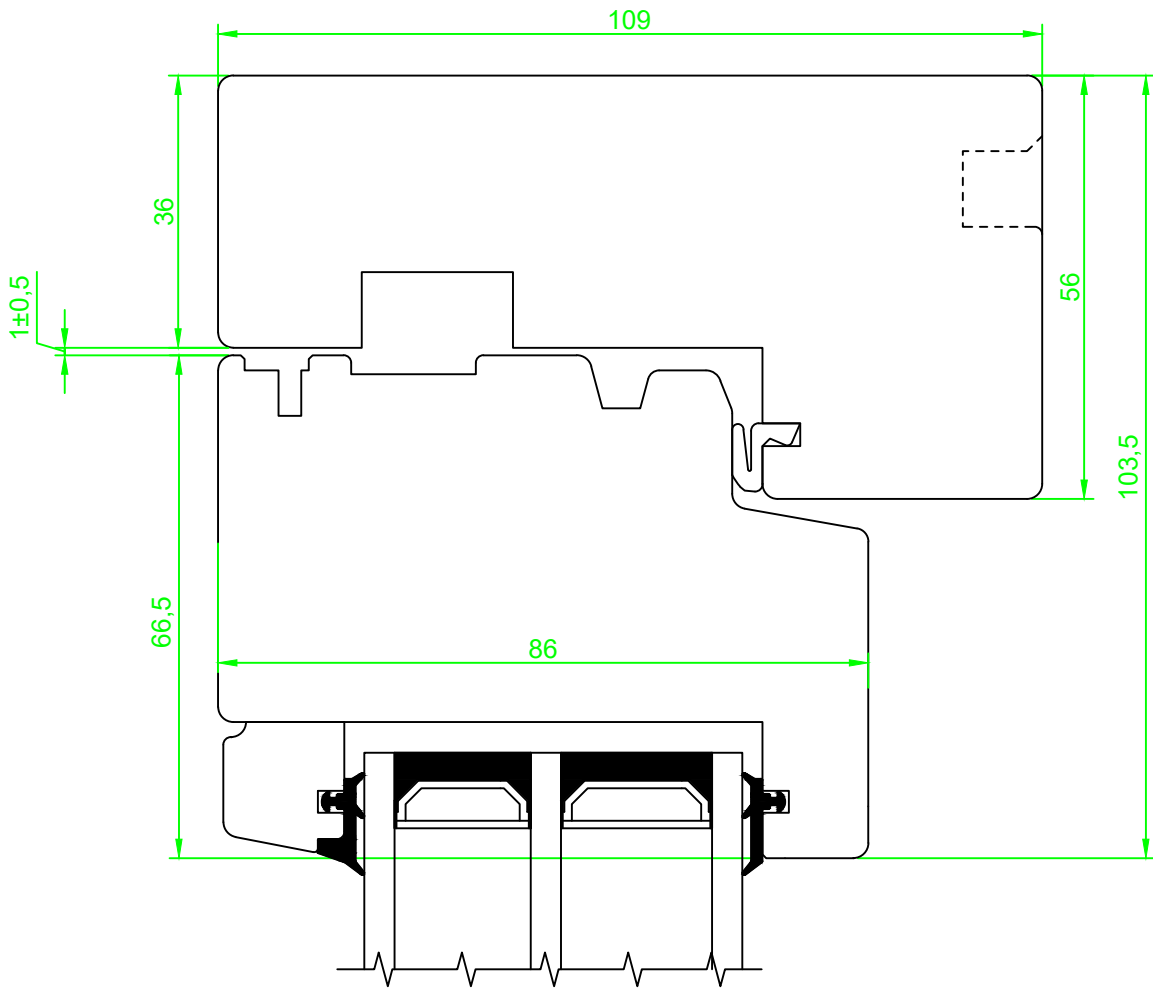



| | | | | | |
|------------------------------------|----------------------|-----------|------------------|---|---------------------------|
| Date. 20.11.2018 | Constr./draw. EAO | Approved. | Scale. A4 1:1 | Review nr. 2 | Review date 25.02.2022 |
| Toppsvingvindu (VUT86), ramme 68mm | | | Material. |  <small>Nordvestvinduet AS N-6713 ALMENNINGEN Tel +47 57 85 25 80 firmapost@nordvestvinduet.no www.nordvestvinduet.no</small> | |
| Vertikalsnitt, bunn | | | Replacement for: | | Drawing nr. |
| Tolerance.: NS-ISO 2768-1-middels. | | | Replaced of: | | VUT86_R68_G50_U |



| | | | | | |
|-------------------------------------|----------------------|-----------|------------------|--|---------------------------|
| Date. 20.11.2018 | Constr./draw. EAO | Approved. | Scale. A4 1:1 | Review nr. 1 | Review date 20.11.2018 |
| Toppssvingvindu (VUT86), ramme 68mm | | | Material. |  <small>Nordvestvinduet AS N-6713 ALMENNINGEN Tel +47 57 85 25 80 firmapost@nordvestvinduet.no www.nordvestvinduet.no</small> | |
| Vertikalsnitt, topp | | | Replacement for: | | Drawing nr. |
| Tolerance.: NS-ISO 2768-1-middels. | | | Replaced of: | | VUT50_R68_G50_O |

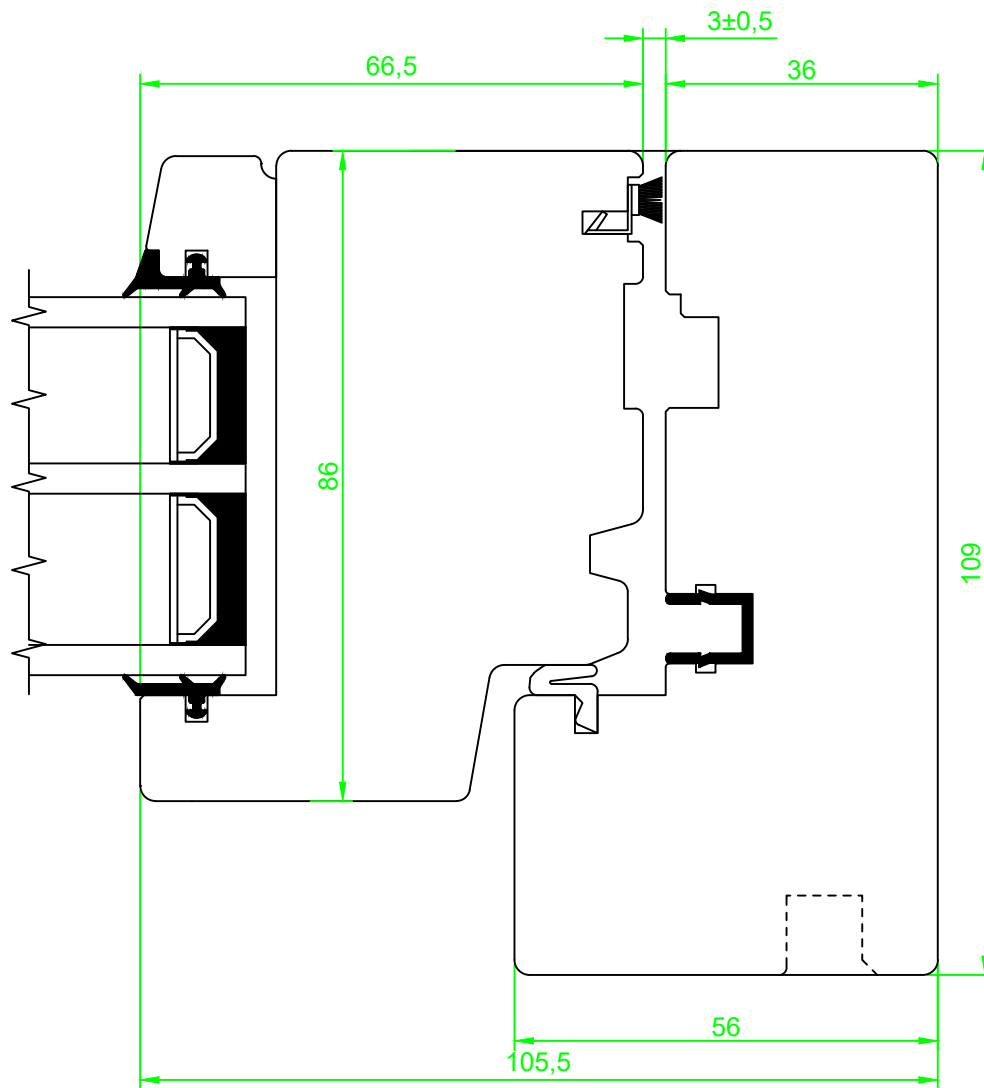

| | | | | | |
|------------------------------------|----------------------|-----------|------------------|---|---------------------------|
| Date. 20.11.2018 | Constr./draw. EAO | Approved. | Scale. A4 1:1 | Review nr. 1 | Review date 20.11.2018 |
| Toppsvingvindu (VUT86), ramme 68mm | | | Material. |  <small>Nordvestvinduet AS N-6713 ALMENNINGEN Tel +47 57 85 25 80 firmapost@nordvestvinduet.no www.nordvestvinduet.no</small> | |
| Horisontalsnitt, side | | | Replacement for: | | Drawing nr. |
| Tolerance.: NS-ISO 2768-1-middels. | | | Replaced of: | | VUT86_R68_G50_S |

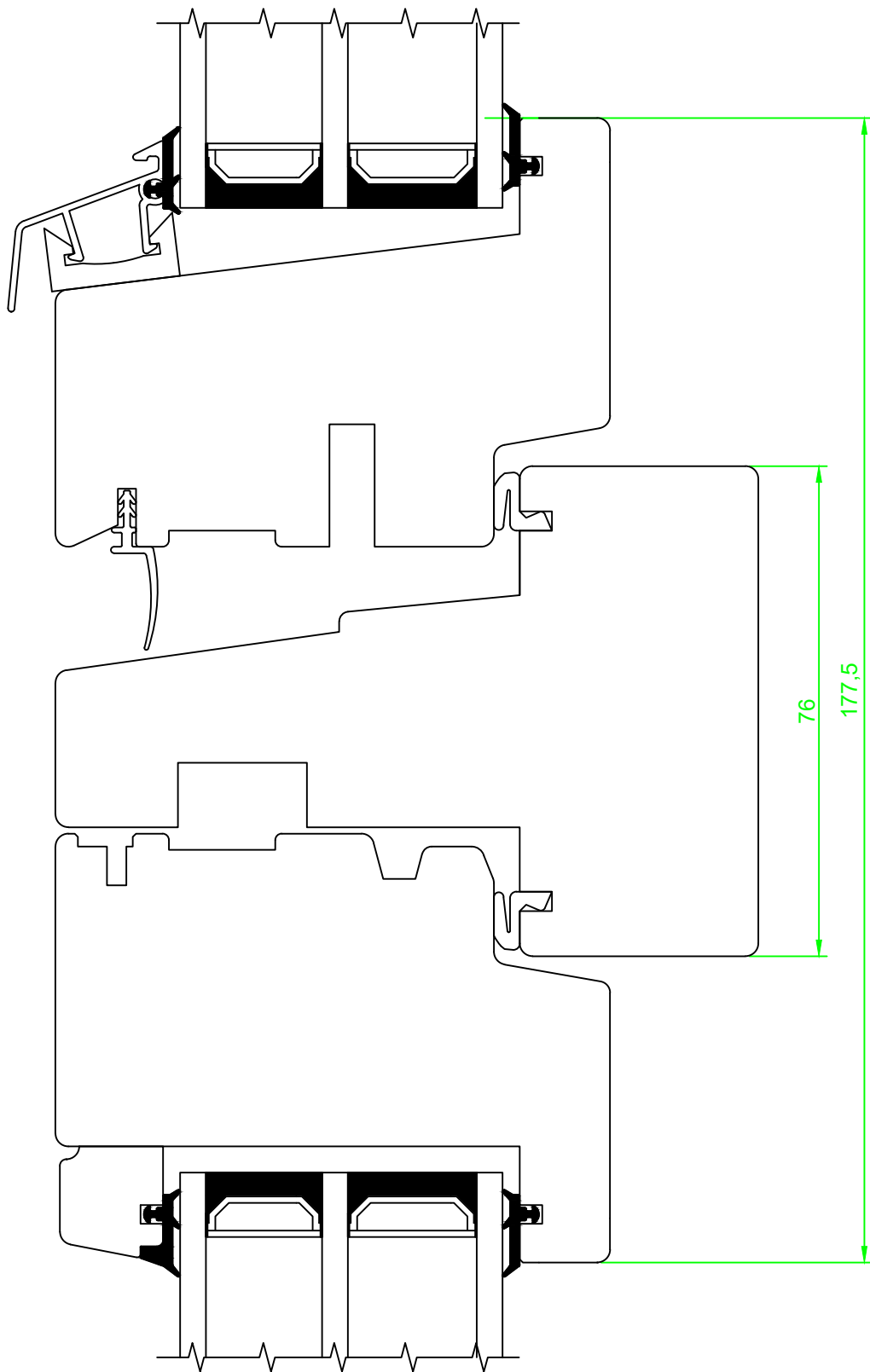

| | | | | | |
|---|-----------------------------|---|-------------------------|---|----------------------------------|
| <i>Date.</i> 20.11.2018 | <i>Constr./draw.</i> EAO | <i>Approved.</i> | <i>Scale.</i> A4 1:1 | <i>Review nr.</i> 1 | <i>Review date</i> 20.11.2018 |
| Toppsvingvindu (VUT86), ramme 68mm, losholt 76mm | | | <i>Material.</i> |  <small>Nordvestvinduet AS N-6713 ALMENNINGEN Tel: +47 57 85 25 80 firmapost@nordvestvinduet.no www.nordvestvinduet.no</small> | |
| | | | <i>Replacement for:</i> | | |
| Vertikalsnitt, topp | <i>Replaced of:</i> | <i>Drawing nr.</i> VUT86_R68_G50_L76 | | | |
| <i>Tolerance.:</i> NS-ISO 2768-1-middels. | | | | | |

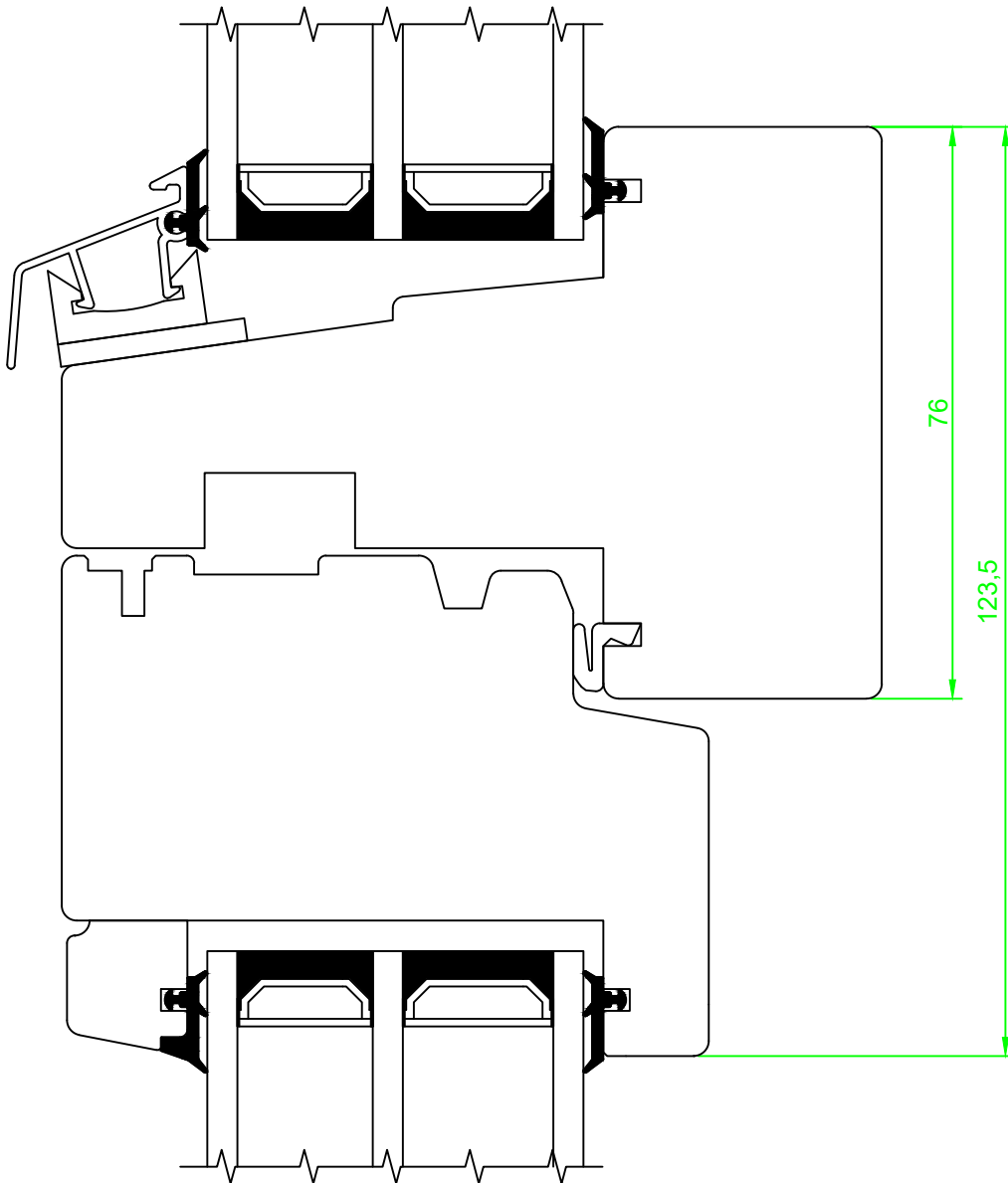

| | | | | | |
|---|-----------------------------|------------------|--|---|--|
| <i>Date.</i> 20.11.2018 | <i>Constr./draw.</i> EAO | <i>Approved.</i> | <i>Scale.</i> A4 1:1 | <i>Review nr.</i> 1 | <i>Review date</i> 20.11.2018 |
| Toppsvingvindu (VUT86), ramme 68mm, losholt 76mm Vertikalsnitt, topp <i>Tolerance.: NS-ISO 2768-1-middels.</i> | | | <i>Material.</i> <i>Replacement for:</i> <i>Replaced of:</i> |  <i>Drawing nr.</i> VUT86_R68_G50_L760 | <small>Nordvestvinduet AS N-6713 ALMENNINGEN Tel +47 57 85 25 80 firmapost@nordvestvinduet.no www.nordvestvinduet.no</small> |

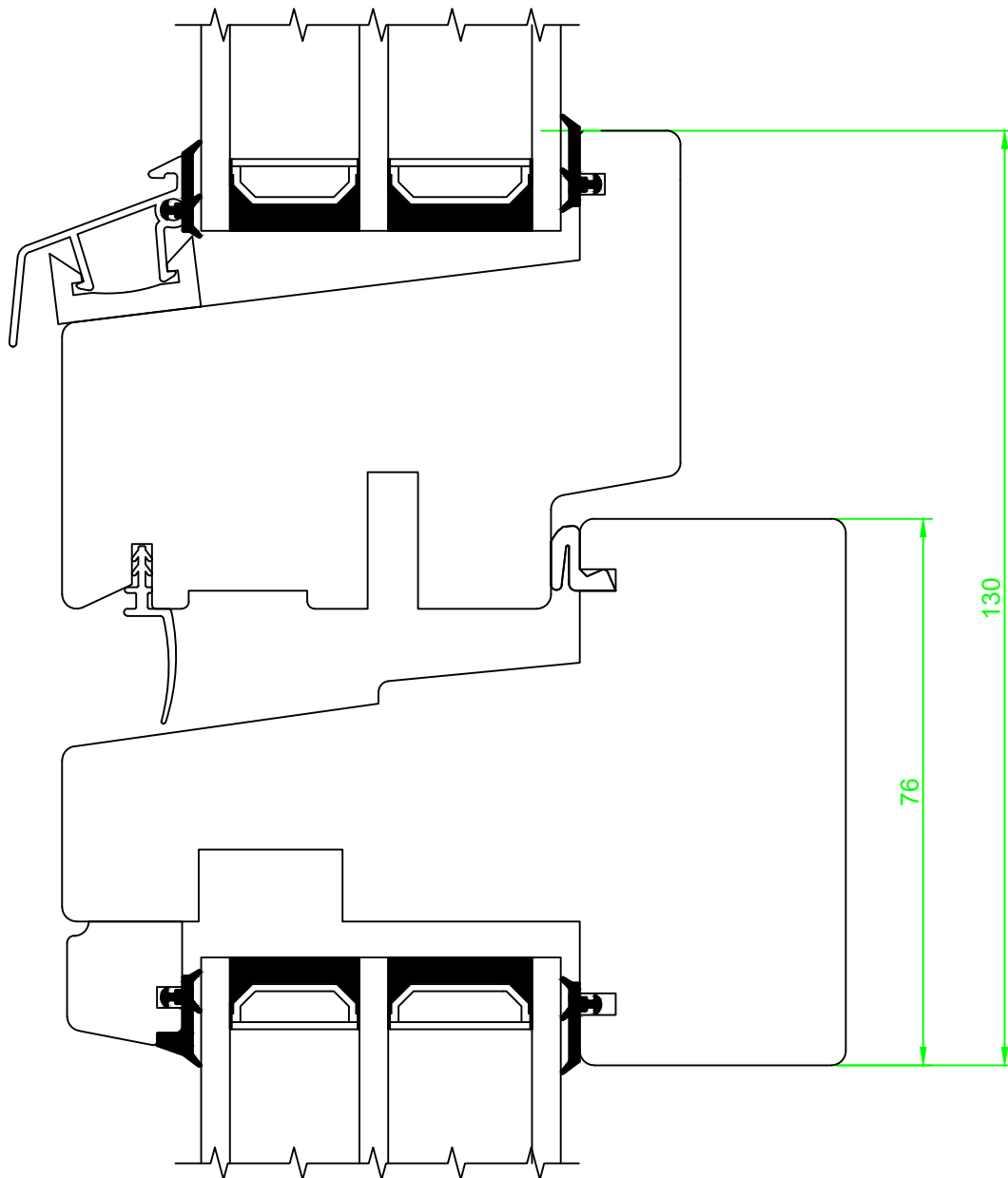

| | | | | | |
|---|-----------------------------|------------------|-------------------------|--|----------------------------------|
| <i>Date.</i> 20.11.2018 | <i>Constr./draw.</i> EAO | <i>Approved.</i> | <i>Scale.</i> A4 1:1 | <i>Review nr.</i> 1 | <i>Review date</i> 20.11.2018 |
| Toppsvingvindu (VUT86), ramme 68mm, losholt 76mm | | | <i>Material.</i> |  <small>Nordvestvinduet AS N-6713 ALMENNINGEN Tel +47 57 85 25 80 firmapost@nordvestvinduet.no www.nordvestvinduet.no</small> | |
| | | | <i>Replacement for:</i> | | |
| Vertikalsnitt, topp | | | <i>Replaced of:</i> | VUT86_R68_G50_L76U | |
| <i>Tolerance.: NS-ISO 2768-1-middels.</i> | | | | | |

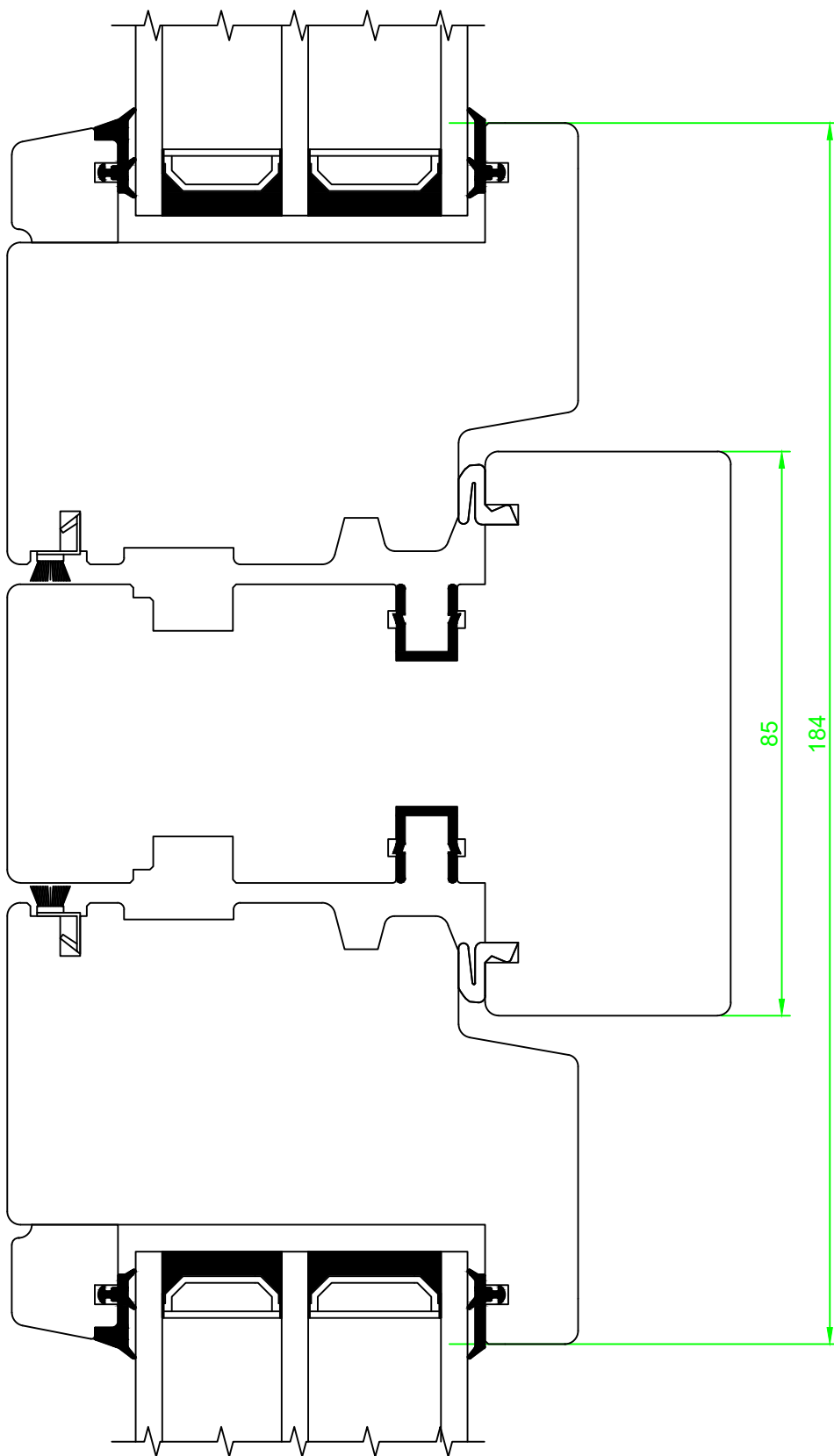

| | | | | | |
|--|----------------------|-----------|------------------|---|---------------------------|
| Date. 20.11.2018 | Constr./draw. EAO | Approved. | Scale. A4 1:1 | Review nr. 1 | Review date 20.11.2018 |
| Toppsvingvindu (VUT86), ramme 68mm, post 85mm | | | Material. |  Nordvestvinduet AS N-6713 ALMENNINGEN Tel +47 57 85 25 80 firmapost@nordvestvinduet.no www.nordvestvinduet.no | |
| | | | Replacement for: | | |
| Horizontalsnitt, topp | | | Replaced of: | VUT86_R68_G50_P85 | |
| Tolerance.: NS-ISO 2768-1-middels. | | | | | |

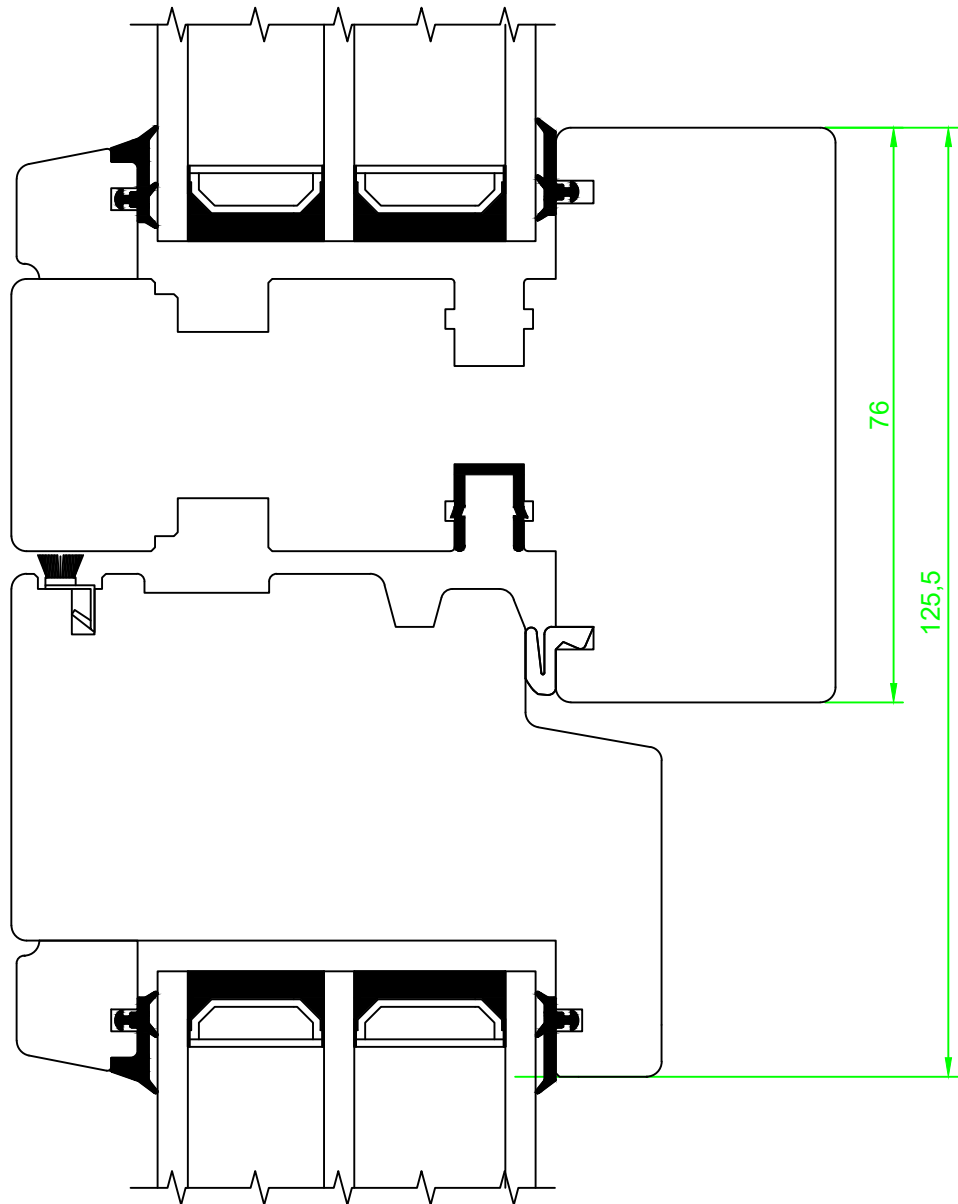

| | | | | | |
|--|-----------------------------|------------------|-------------------------|--|---|
| <i>Date.</i> 20.11.2018 | <i>Constr./draw.</i> EAO | <i>Approved.</i> | <i>Scale.</i> A4 1:1 | <i>Review nr.</i> 1 | <i>Review date</i> 20.11.2018 |
| Toppsvingvindu (VUT86), ramme 68mm, post 76mm | | | <i>Material.</i> |  Nordvestvinduet AS N-6713 ALMENNINGEN Tel: +47 57 85 25 80 firmapost@nordvestvinduet.no www.nordvestvinduet.no | <i>Drawing nr.</i> VUT86_R68_G50_P76 |
| | | | <i>Replacement for:</i> | | |
| Horisontalsnitt, topp | | | <i>Replaced of:</i> | | |
| <i>Tolerance.: NS-ISO 2768-1-middels.</i> | | | | | |