

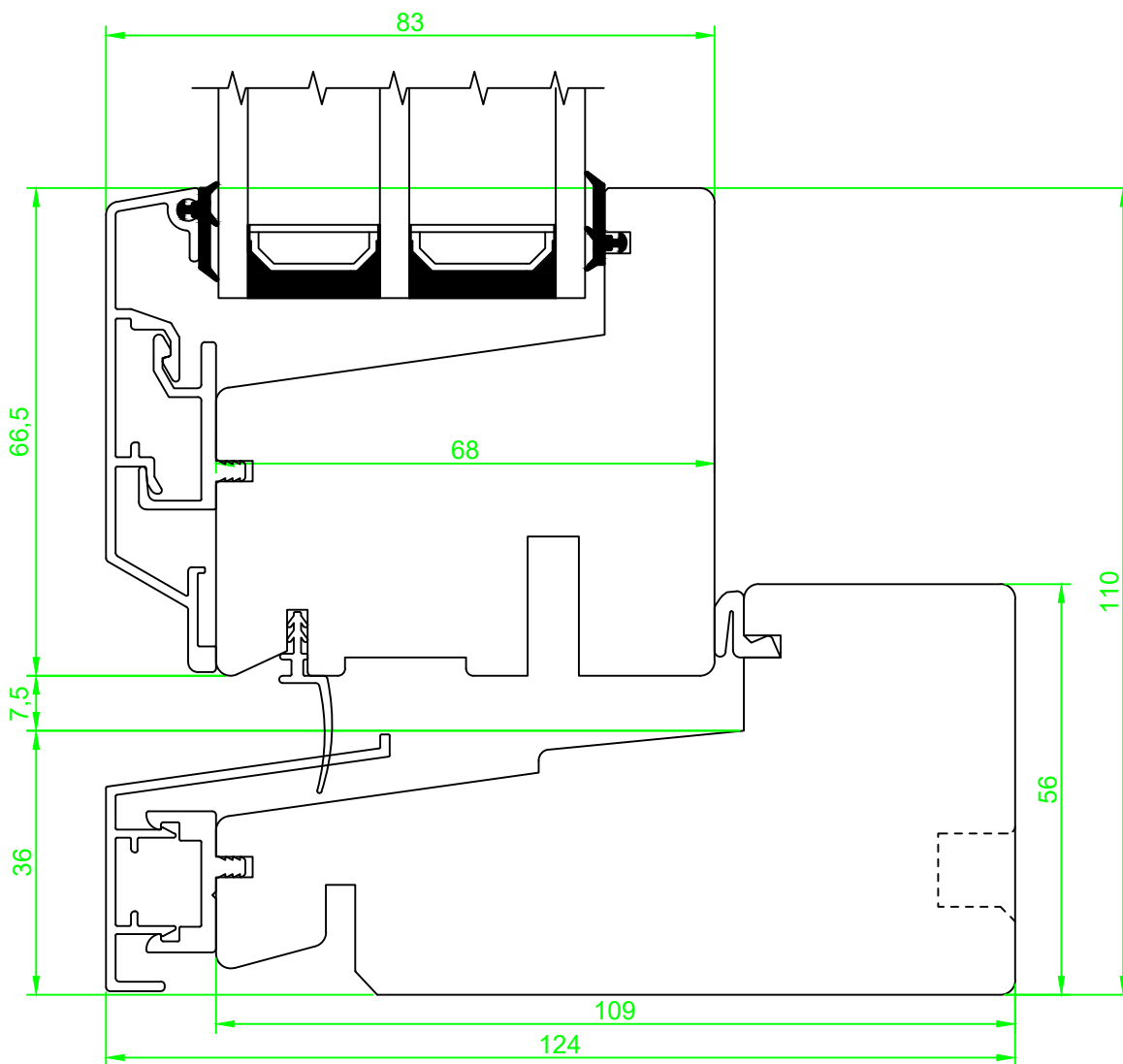

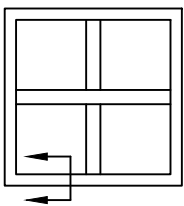

| | | | | | |
|--|------------------------|-----------|------------------------------------|---|-------------------------------------|
| Date. 16.11.2017 | Constr./draw. JAEAO | Approved. | Scale. A4 1:1 | Review nr. 8 | Review date 28.02.2022 |
| Toppengslet vindu i tre/aluminium Karm 109/124mm, Ramme 68mm, Glass 50mm | | | Section: Vertikal |  <small>Nordvestvinduet AS N-6713 ALMENNINGEN Tel +47 57 85 25 80 firmapost@nordvestvinduet.no www.nordvestvinduet.no</small> | |
| | | | Part: Bunn | | Drawing nr. VUA_TH_R68_G50_B_Esp |
| | | | Tolerance.: NS-ISO 2768-1-middels. | | |



| | | | | | |
|--|-------------------------|-----------|------------------------------------|--|---------------------------|
| Date. 16.11.2017 | Constr./draw. JA/EAO | Approved. | Scale. A4 1:1 | Review nr. 8 | Review date 28.02.2022 |
| Toppengslet vindu i tre/aluminium Karm 109/124mm, Ramme 68mm, Glass 50mm | | | Section: Vertikal |  <small>Nordvestvinduet AS N-6713 ALMENNINGEN Tel +47 57 85 25 80 firmapost@nordvestvinduet.no www.nordvestvinduet.no</small> | |
| | | | Part: Bunn | | |
| | | | Tolerance.: NS-ISO 2768-1-middels. | Design: Trend | |

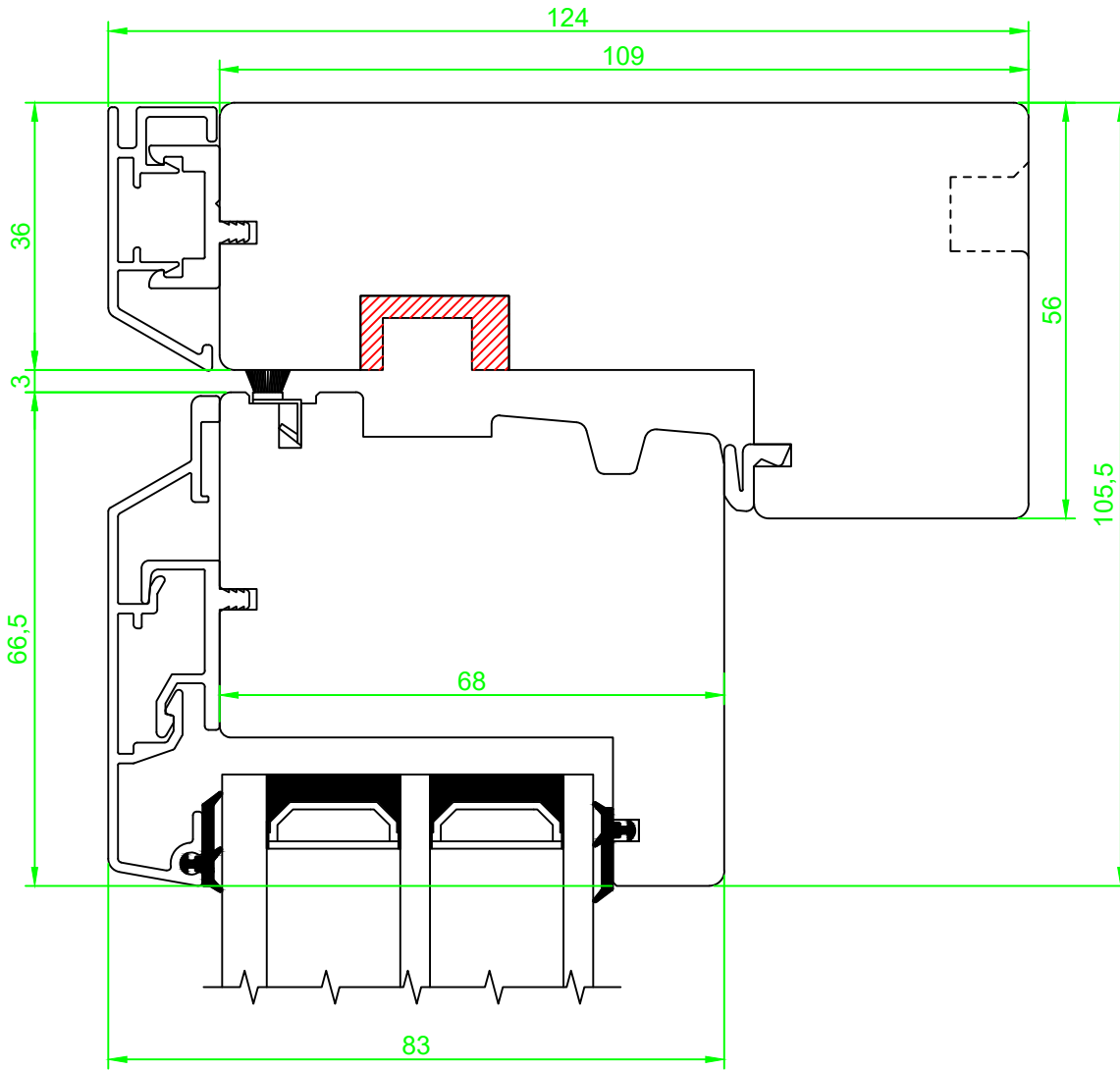
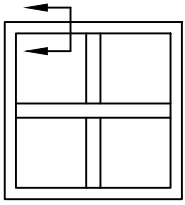

| | | | | | | |
|---|-------------------------|-----------|----------------------|--|---------------------------|---------------------------------|
| Date. 16.11.2017 | Constr./draw. JA/EAO | Approved. | Scale. A4 1:1 | Review nr. 8 | Review date 28.02.2022 | |
| Topphengslet vindu i tre/aluminium Karm 109/124mm, Ramme 68mm, Glass 50mm | | | Section: Vertikal |  <small>Nordvestvinduet AS N-6713 ALMENNINGEN Tel +47 57 85 25 80 firmapost@nordvestvinduet.no www.nordvestvinduet.no</small> | | |
| | | | Part: Topp | | | Drawing nr. VUA_TH_R68_G50_O |
| | | | Design: Trend | | | |
| Tolerance.: NS-ISO 2768-1-middels. | | | | | | |

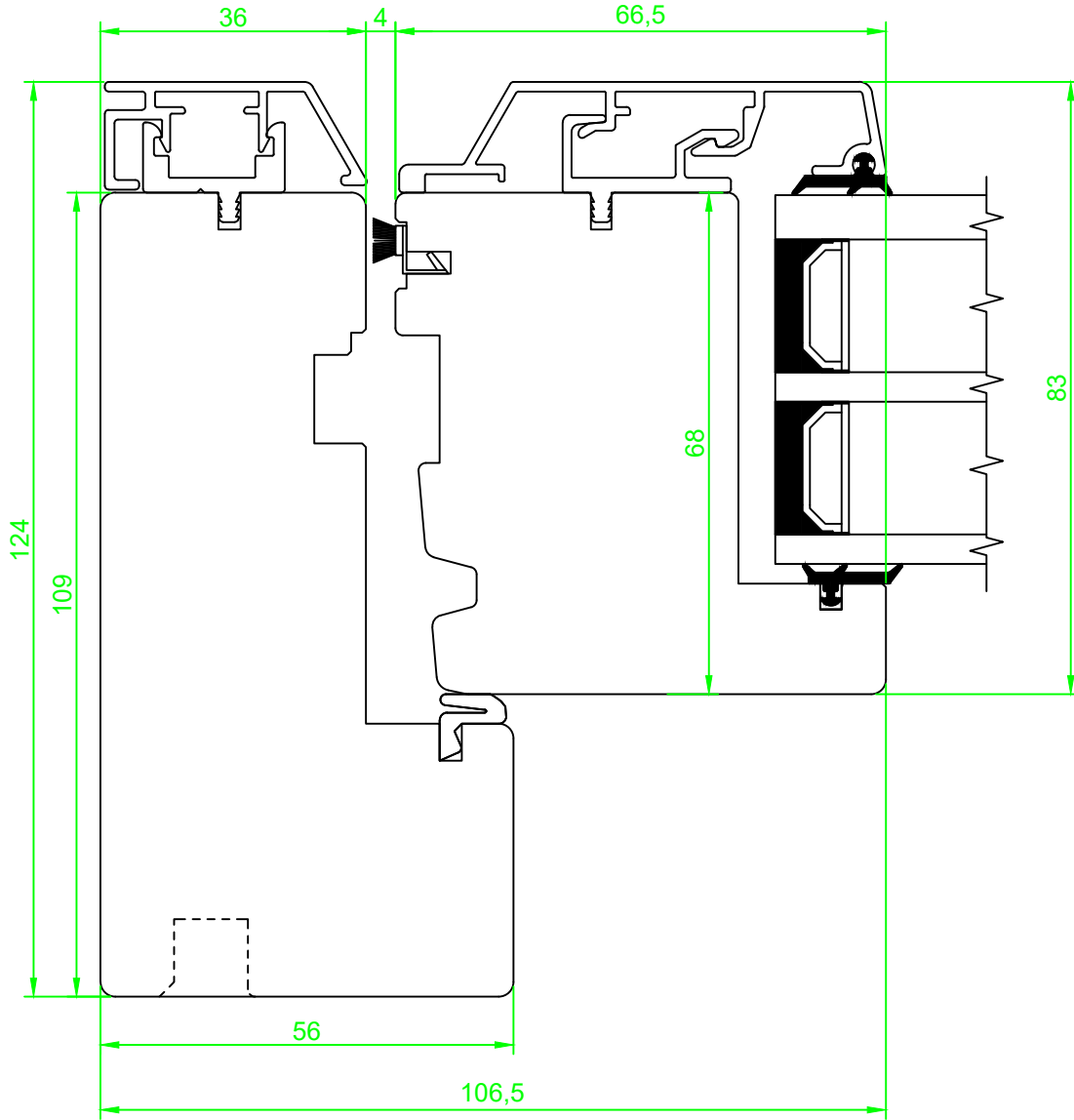
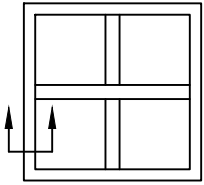

| | | | | | |
|--|--------------------------------|------------------|--|--|----------------------------------|
| <i>Date.</i> 16.11.2017 | <i>Constr./draw.</i> JA/EAO | <i>Approved.</i> | <i>Scale.</i> A4 1:1 | <i>Review nr.</i> 8 | <i>Review date</i> 28.02.2022 |
| Toppengslet vindu i tre/aluminium Karm 109/124mm, Ramme 68mm, Glass 50mm | | | <i>Section:</i> Horizontal |  <small>Nordvestvinduet AS N-5713 ALMENNINGEN Tel +47 57 85 25 80 firmapost@nordvestvinduet.no www.nordvestvinduet.no</small> | |
| | | | <i>Part:</i> Hengsleside | | |
| | | | <i>Design:</i> Trend | | |
| <i>Tolerance.:</i> NS-ISO 2768-1-middels. | | | <i>Drawing nr.</i> VUA_TH_R68_G50_S | | |

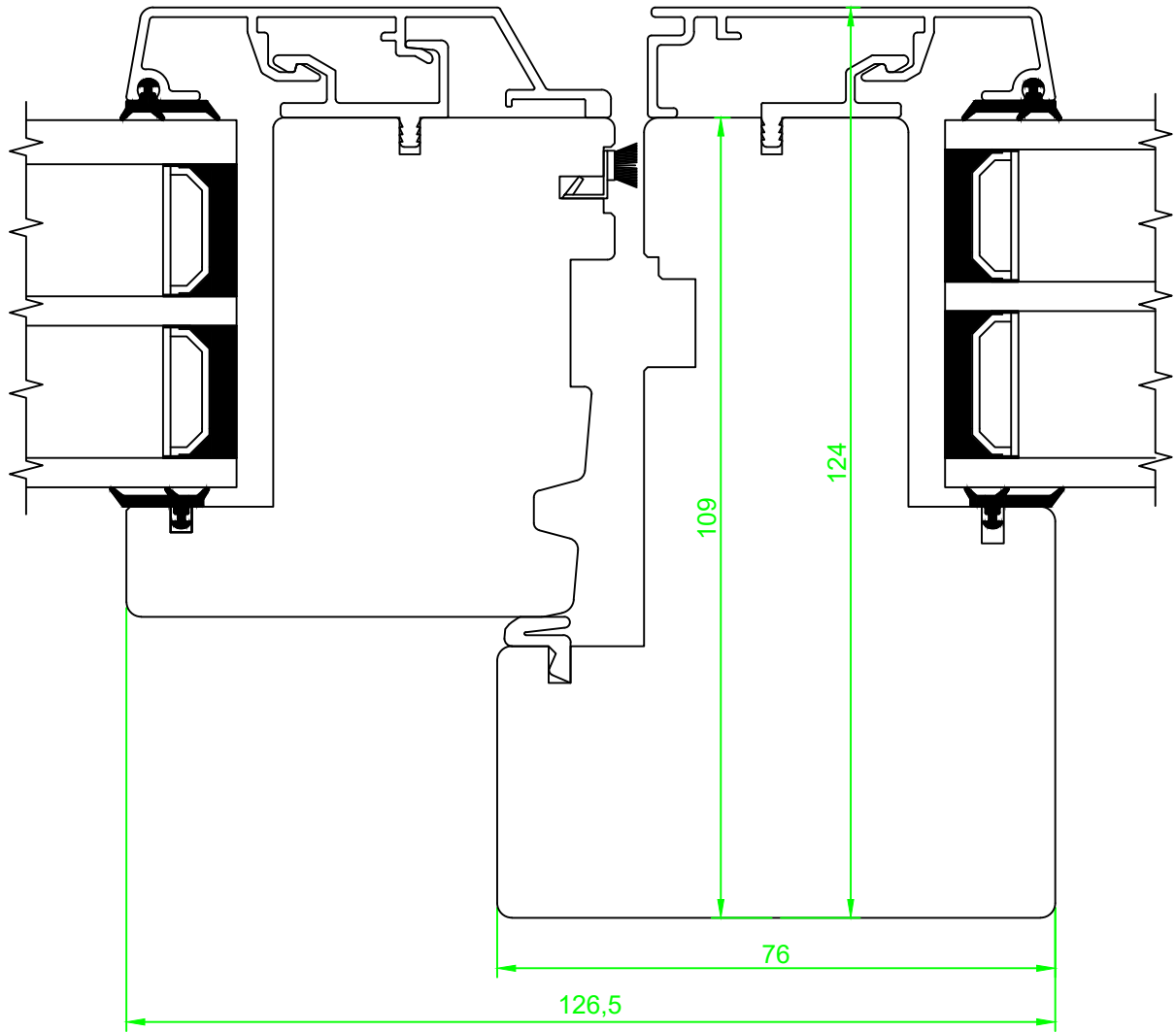
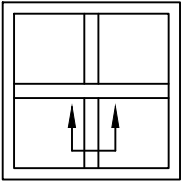

| | | | | | |
|--|--------------------------------|------------------|---|--|----------------------------------|
| <i>Date.</i> 16.11.2017 | <i>Constr./draw.</i> JA/EAO | <i>Approved.</i> | <i>Scale.</i> A4 1:1 | <i>Review nr.</i> 8 | <i>Review date</i> 28.02.2022 |
| Toppengslet vindu i tre/aluminium Karm 109/124mm, Ramme 68mm, Glass 50mm | | | <i>Section:</i> Horizontal |  <small>Nordvestvinduet AS N-6713 ALMENNINGEN Tel +47 57 85 25 80 firmapost@nordvestvinduet.no www.nordvestvinduet.no</small> | |
| | | | <i>Part:</i> Post | | |
| | | | <i>Tolerance.:</i> NS-ISO 2768-1-middels. | <i>Design:</i> Trend | |

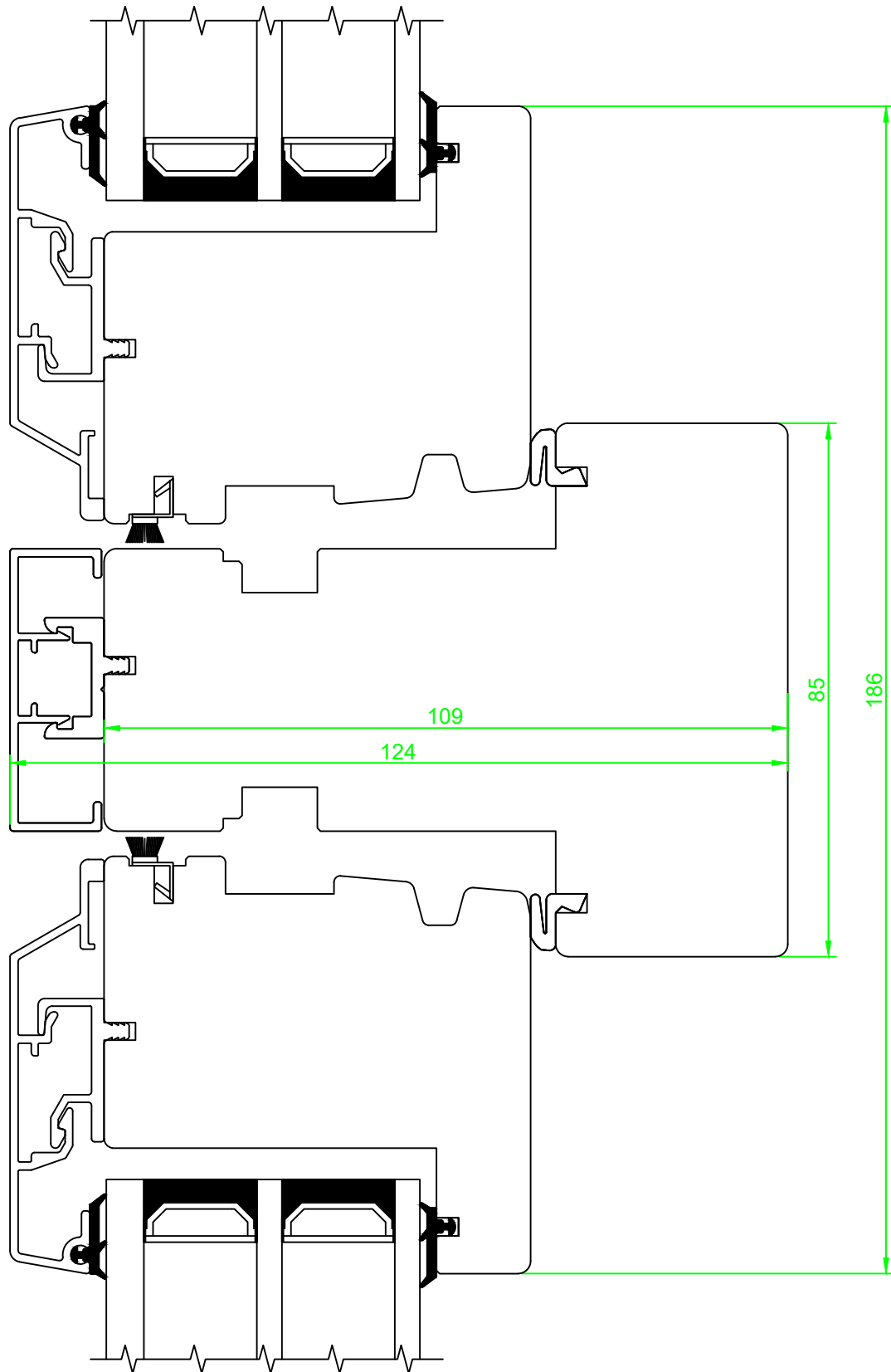
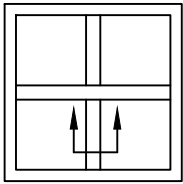

| | | | | | |
|--|-------------------------|-----------|------------------------|---|-----------------------------------|
| Date. 16.11.2017 | Constr./draw. JA/EAO | Approved. | Scale. A4 1:1 | Review nr. 8 | Review date 28.02.2022 |
| Tophengslet vindu i tre/aluminium Karm 109/124mm, Ramme 68mm, Glass 50mm | | | Section: Horizontal |  Nordvestvinduet AS N-6713 ALMENNINGEN Tel +47 57 85 25 80 firmapost@nordvestvinduet.no www.nordvestvinduet.no | |
| | | | Part: Post | | Drawing nr. VUA_TH_R68_G50_P85 |
| | | | Design: Trend | | |
| Tolerance.: NS-ISO 2768-1-middels. | | | | | |

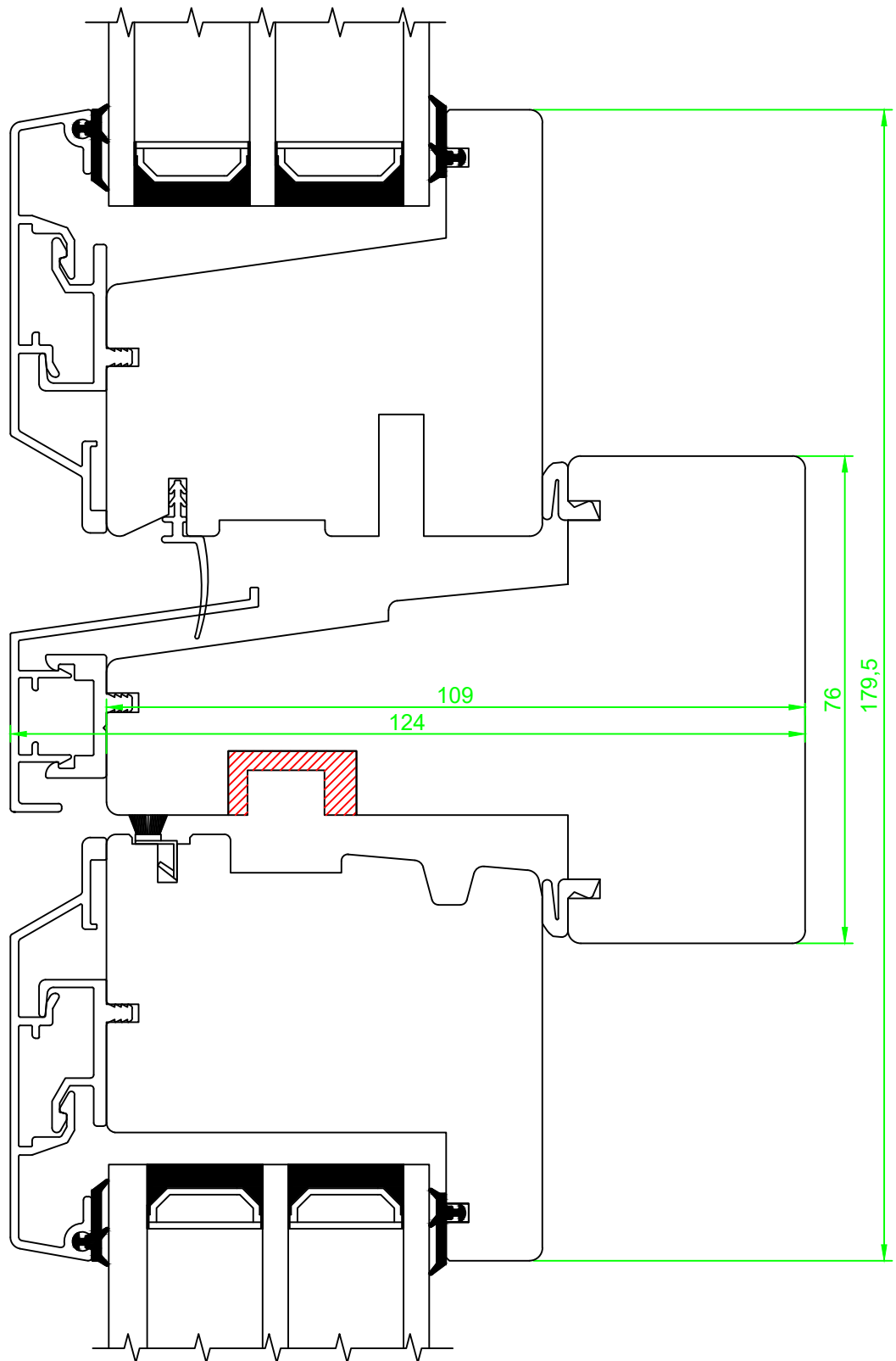
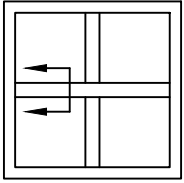

| | | | | | |
|--|-------------------------|-----------|------------------------------------|---|---------------------------|
| Date. 16.11.2017 | Constr./draw. JA/EAO | Approved. | Scale. A4 1:1 | Review nr. 8 | Review date 28.02.2022 |
| Toppengslet vindu i tre/aluminium Karm 109/124mm, Ramme 68mm, Glass 50mm | | | Section: Vertikal |  <small>Nordvestvinduet AS N-6713 ALMENNINGEN Tel. +47 57 85 25 80 firmapost@nordvestvinduet.no www.nordvestvinduet.no</small> | |
| | | | Part: Losholt | | |
| | | | Tolerance.: NS-ISO 2768-1-middels. | Design: Trend | |

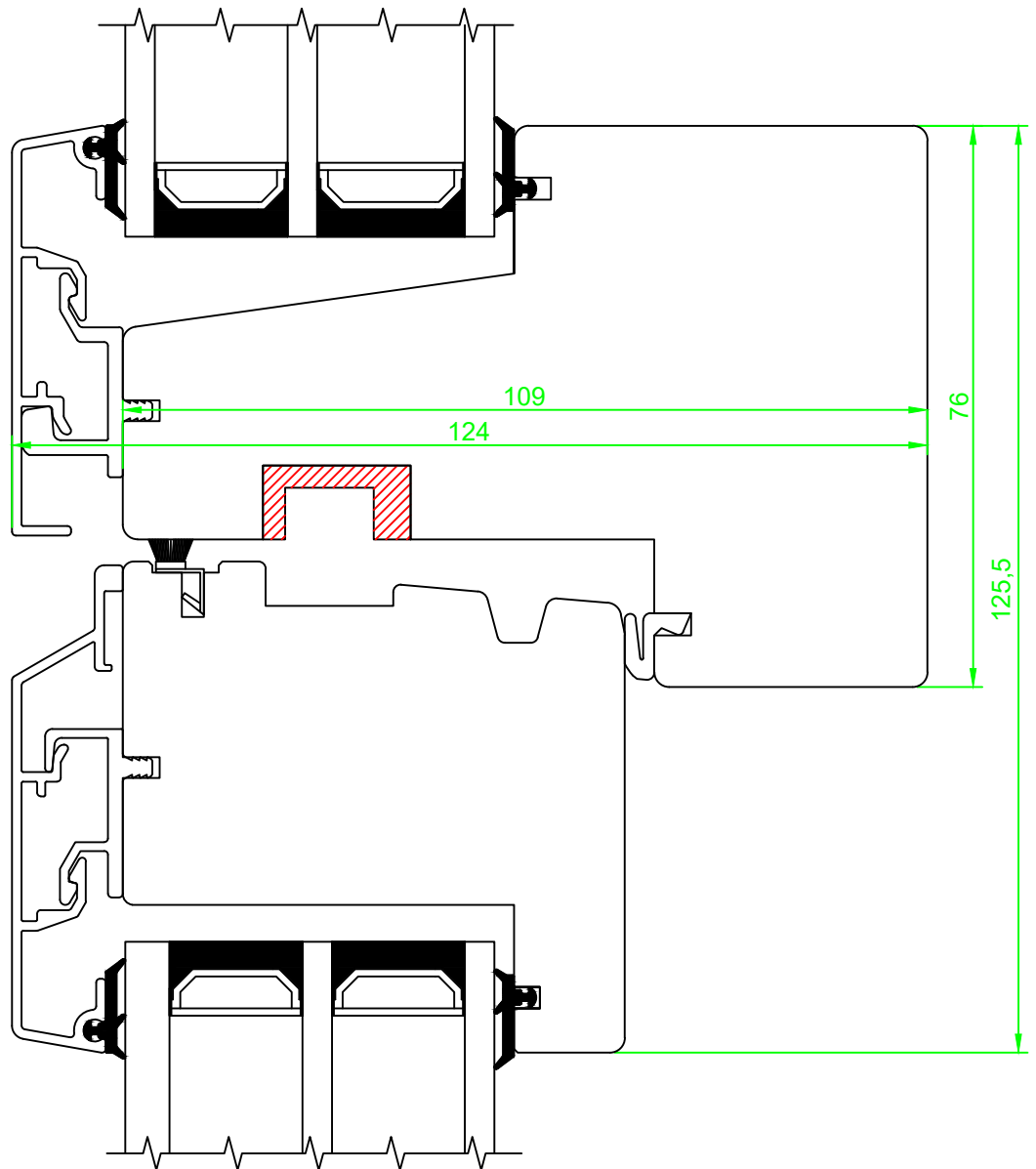
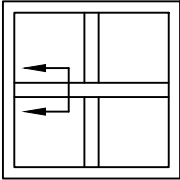

| | | | | | |
|--|-------------------------|-----------|------------------------------------|--|---------------------------|
| Date. 16.11.2017 | Constr./draw. JA/EAO | Approved. | Scale. A4 1:1 | Review nr. 8 | Review date 28.02.2022 |
| Toppengslet vindu i tre/aluminium Karm 109/124mm, Ramme 68mm, Glass 50mm | | | Section: Vertikal |  <small>Nordvestvinduet AS N-6713 ALMENNINGEN Tel +47 57 85 25 80 firmapost@nordvestvinduet.no www.nordvestvinduet.no</small> | |
| | | | Part: Losholt | | |
| | | | Tolerance.: NS-ISO 2768-1-middels. | Design: Trend | |

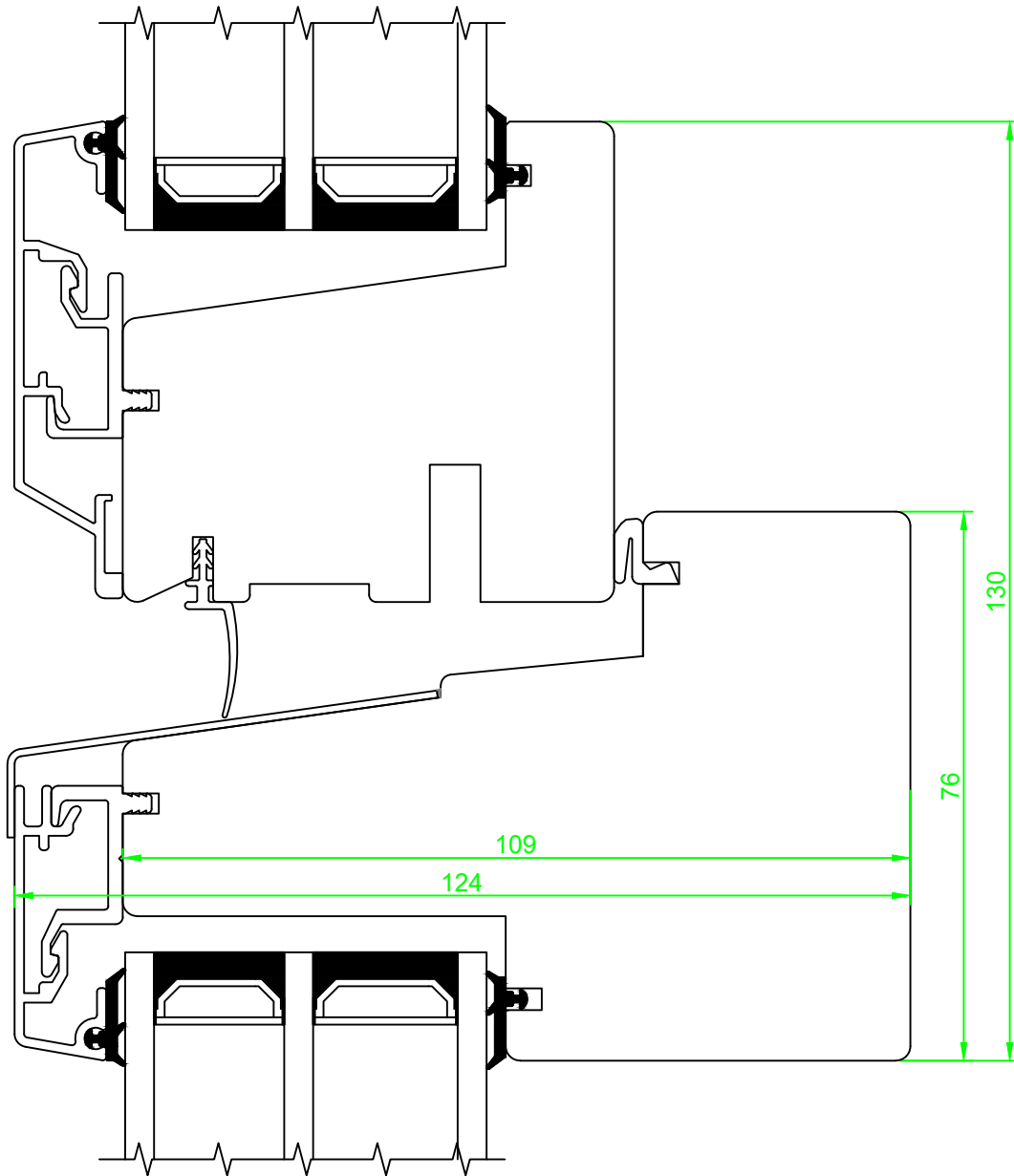
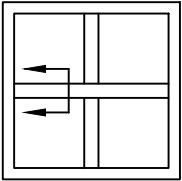

| | | | | | |
|--|-------------------------|-----------|------------------------------------|---|--|
| Date. 16.11.2017 | Constr./draw. JA/EAO | Approved. | Scale. A4 1:1 | Review nr. 8 | Review date 28.02.2022 |
| Suphengstet vindu i tre/Aluminium Karm 109/124mm, Rasthøle 76mm, Blått 50mm, Glass 50mm | | | Section: Vertikal |  | <small>Nordvestvinduet AS N-6713 ALMENNINGEN Tel +47 57 85 25 80 firmapost@nordvestvinduet.no www.nordvestvinduet.no</small> |
| | | | Part: Losholt | | |
| | | | Tolerance.: NS-ISO 2768-1-middels. | | |