

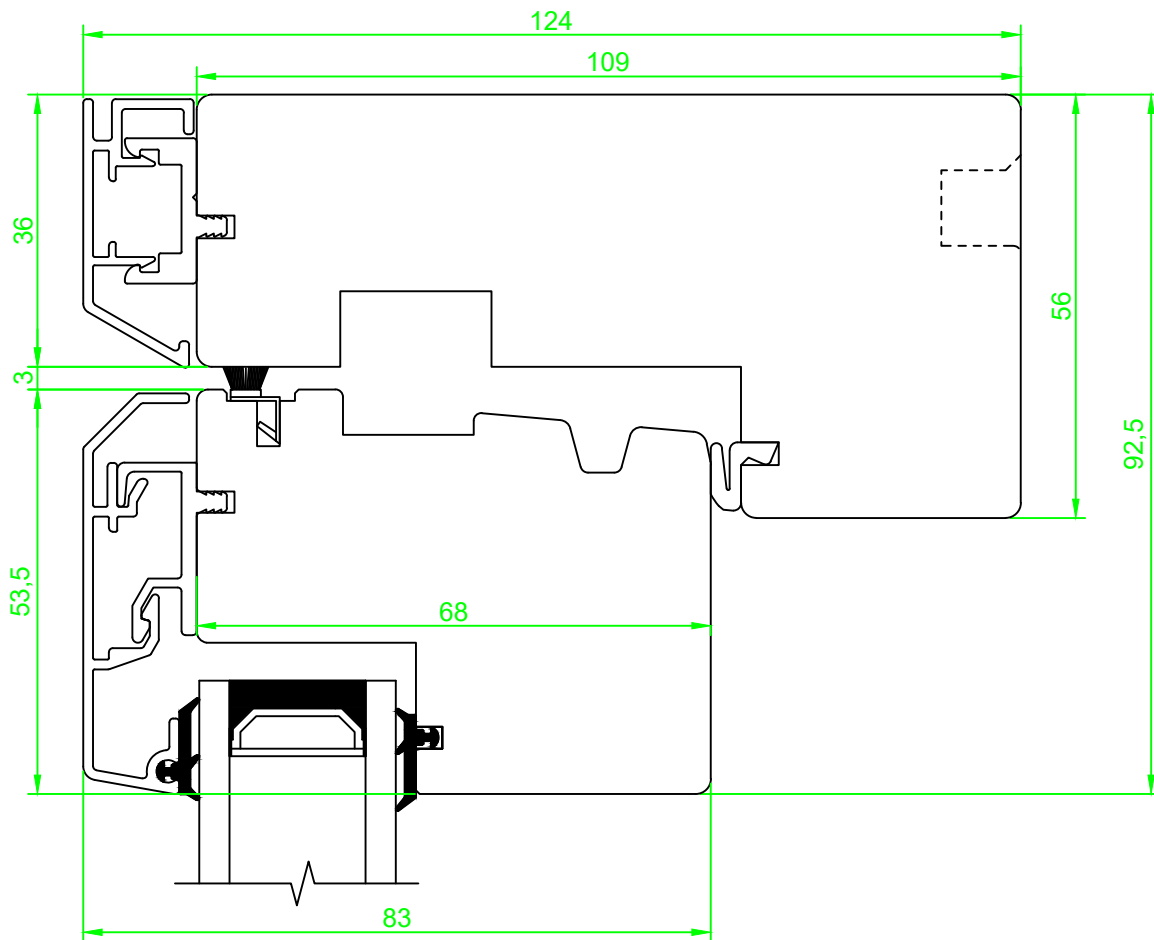

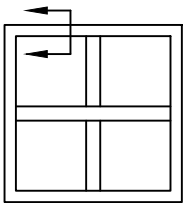

Date. 23.06.2014	Constr./draw. JA/EAO	Approved.	Scale. A4 1:1	Review nr. 5	Review date 30.09.2022
Sidehengsla vindu i tre/aluminium 109mm karm, 55mm ramme Vertikalsnitt bunn, design Trend			Section:	 Nordvestvinduet AS N-6713 ALMENNINGEN Tel +47 57 85 25 80 firmapost@nordvestvinduet.no www.nordvestvinduet.no	
			Part:		
			Tolerance.: NS-ISO 2768-1-middels.	Design:	



Date. 23.06.2014	Constr./draw. JA/EAO	Approved.	Scale. A4 1:1	Review nr. 5	Review date 30.09.2022
Sidehengsla vindu i tre/aluminium 109mm karm, 55mm ramme Vertikalsnitt topp, design Trend			Section:	 <small>Nordvestvinduet AS N-6713 ALMENNINGEN Tel +47 57 85 25 80 firmapost@nordvestvinduet.no www.nordvestvinduet.no</small>	
			Part:		
			Design:		
Tolerance.: NS-ISO 2768-1-middels.			VUA_TR_R55_O		

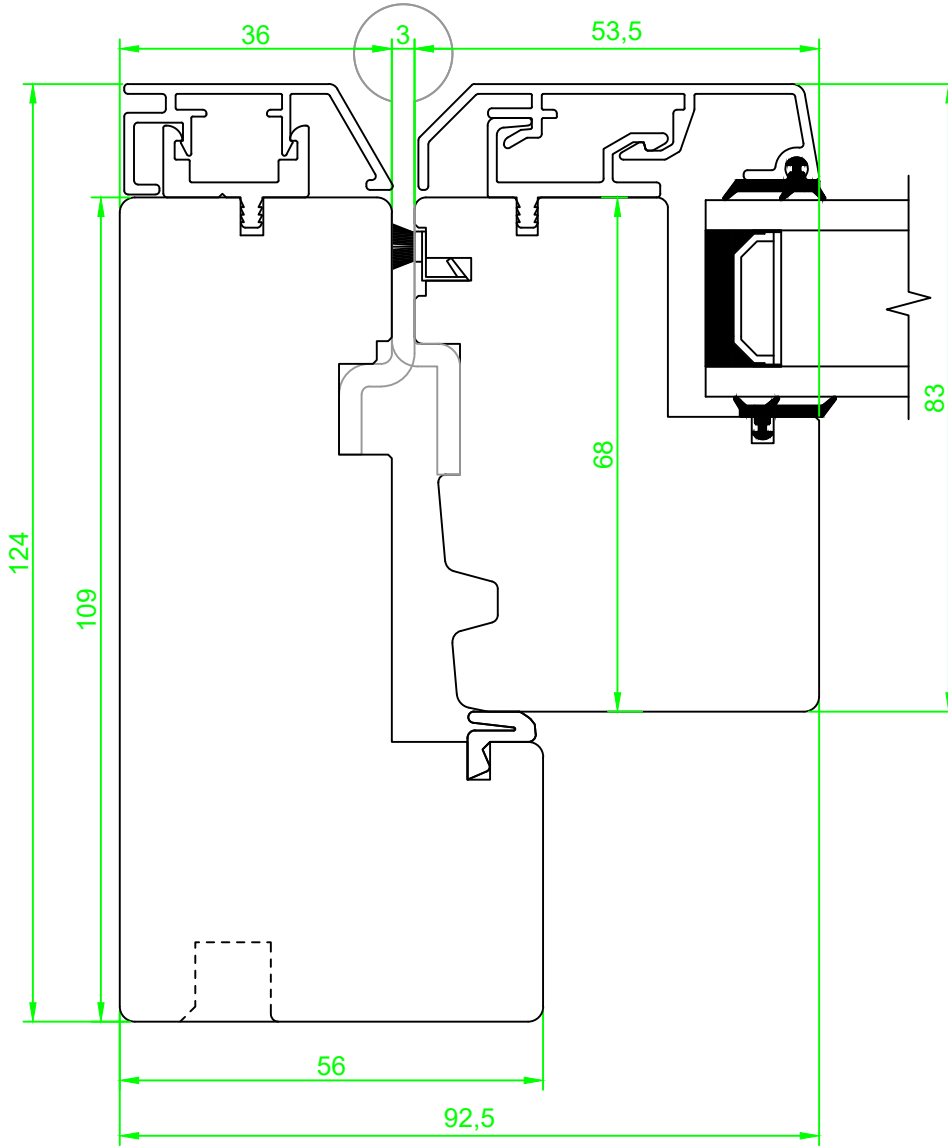
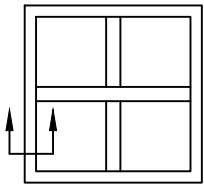

<i>Date.</i> 23.06.2014	<i>Constr./draw.</i> JA/EAO	<i>Approved.</i>	<i>Scale.</i> A4 1:1	<i>Review nr.</i> 5	<i>Review date</i> 30.09.2022	
Sidehengsla vindu i tre/aluminium 109mm karm, 55mm ramme Horisontalsnitt hengsleside, design Trend			<i>Section:</i>	 <small>Nordvestvinduet AS N-6713 ALMENNINGEN Tel +47 57 85 25 80 firmapost@nordvestvinduet.no www.nordvestvinduet.no</small>		
			<i>Part:</i>			<i>Drawing nr.</i>
			<i>Design:</i>			VUA_TR_R55_HS
<i>Tolerance.:</i> NS-ISO 2768-1-middels.						

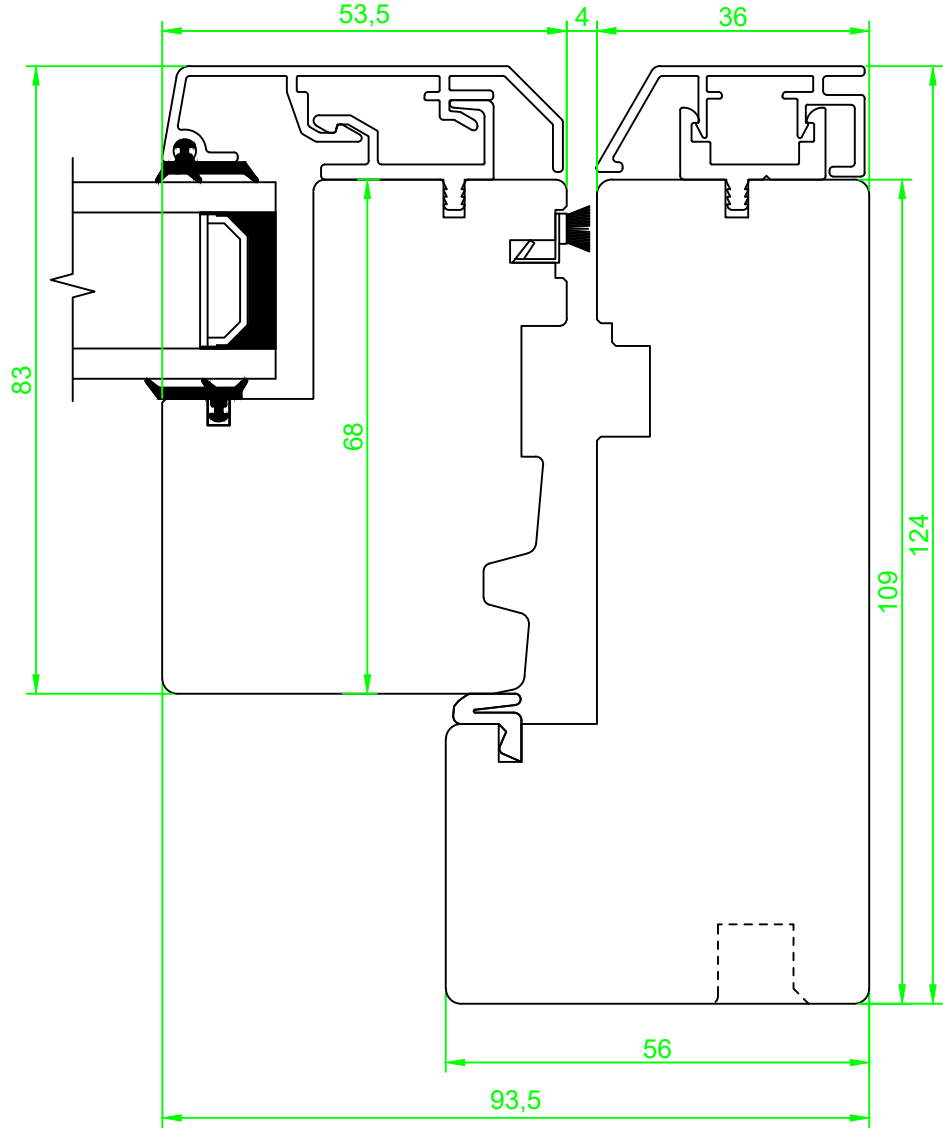
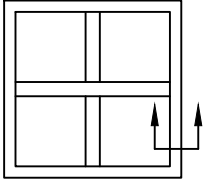

<i>Date.</i> 23.06.2014	<i>Constr./draw.</i> JA/EAO	<i>Approved.</i>	<i>Scale.</i> A4 1:1	<i>Review nr.</i> 5	<i>Review date</i> 30.09.2022	
Sidehengsla vindu i tre/aluminium 109mm karm, 55mm ramme Horizontalsnitt låssideside, design Trend			<i>Section:</i>	 Nordvestvinduet AS N-6713 ALMENNINGEN Tel +47 57 85 25 80 firmapost@nordvestvinduet.no www.nordvestvinduet.no		
			<i>Part:</i>			<i>Drawing nr.</i> VUA_TR_R55_LS
			<i>Design:</i>			
<i>Tolerance.:</i> NS-ISO 2768-1-middels.						

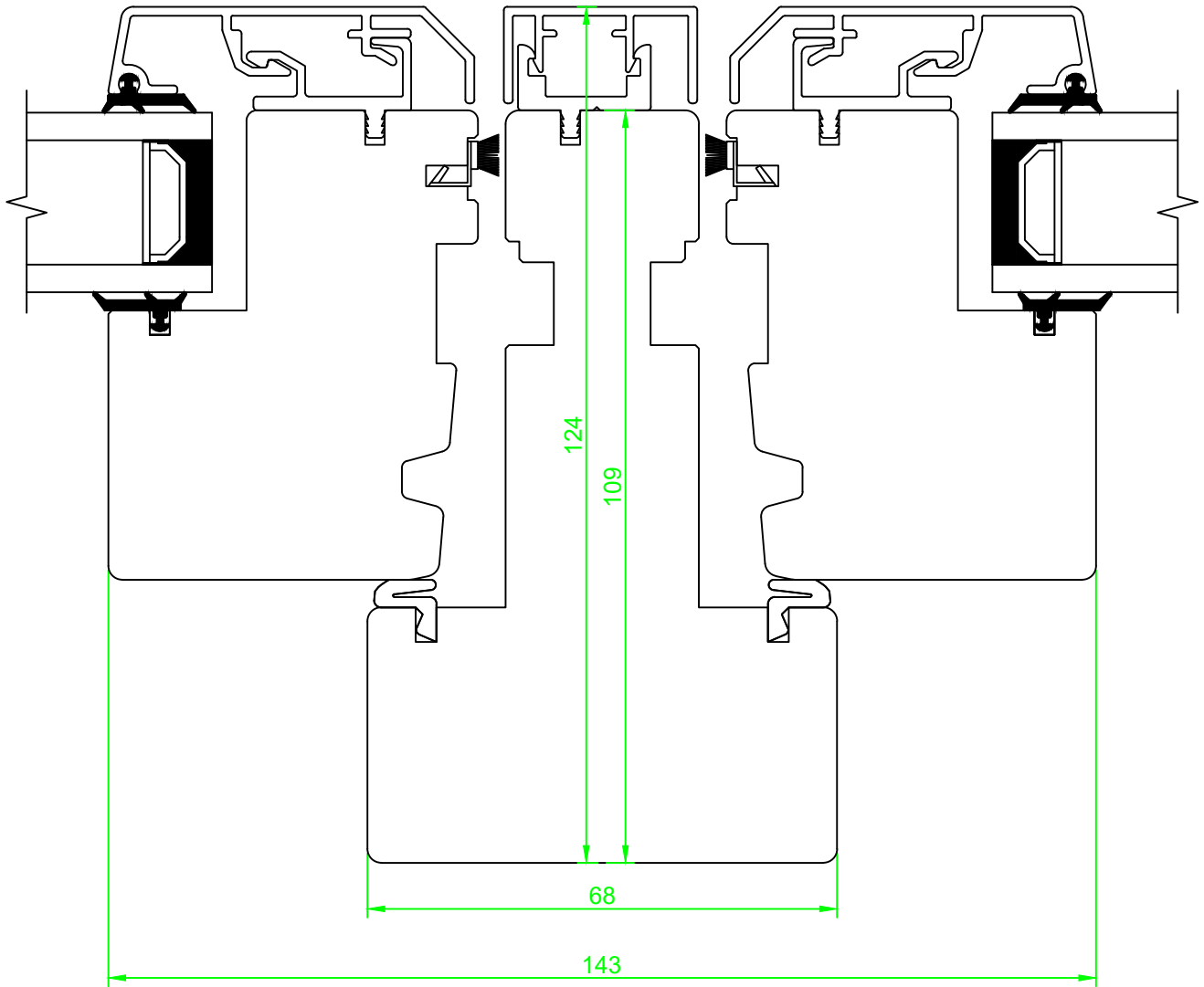
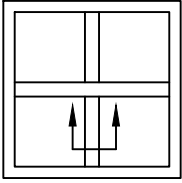

<i>Date.</i> 23.06.2014	<i>Constr./draw.</i> JA/EAO	<i>Approved.</i>	<i>Scale.</i> A4 1:1	<i>Review nr.</i> 5	<i>Review date</i> 30.09.2022
Sidehengsla vindu i tre/aluminium 109mm karm, 55mm ramme Horizontalsnitt post, design Trend			<i>Section:</i>	 Nordvestvinduet AS N-6713 ALMENNINGEN Tel +47 57 85 25 80 firmapost@nordvestvinduet.no www.nordvestvinduet.no	
			<i>Part:</i>		
			<i>Design:</i>		
<i>Tolerance.:</i> NS-ISO 2768-1-middels.			VUA_TR_R55_P68		

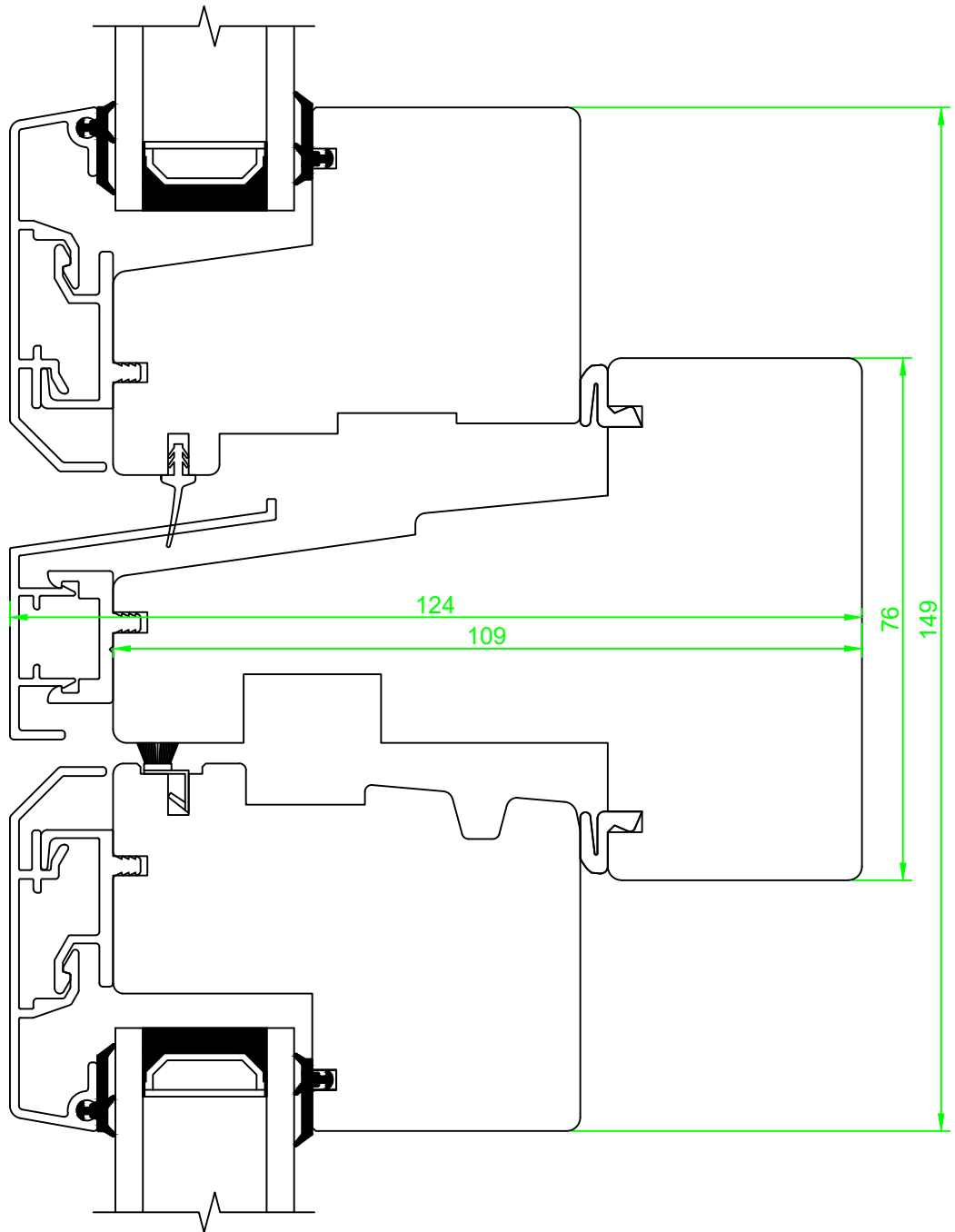
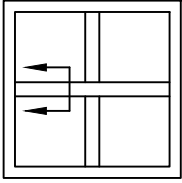

<i>Date.</i> 23.06.2014	<i>Constr./draw.</i> JA/EAO	<i>Approved.</i>	<i>Scale.</i> A4 1:1	<i>Review nr.</i> 5	<i>Review date</i> 30.09.2022
Sidehengsla vindu i tre/aluminium 109mm karm, 55mm ramme Vertikalsnitt losholt, design Trend			<i>Section:</i>		<small>Nordvestvinduet AS N-6713 ALMENNINGEN Tel +47 57 85 25 80 firmapost@nordvestvinduet.no www.nordvestvinduet.no</small>
			<i>Part:</i>		
			<i>Design:</i>		
<i>Tolerance.:</i> NS-ISO 2768-1-middels.					

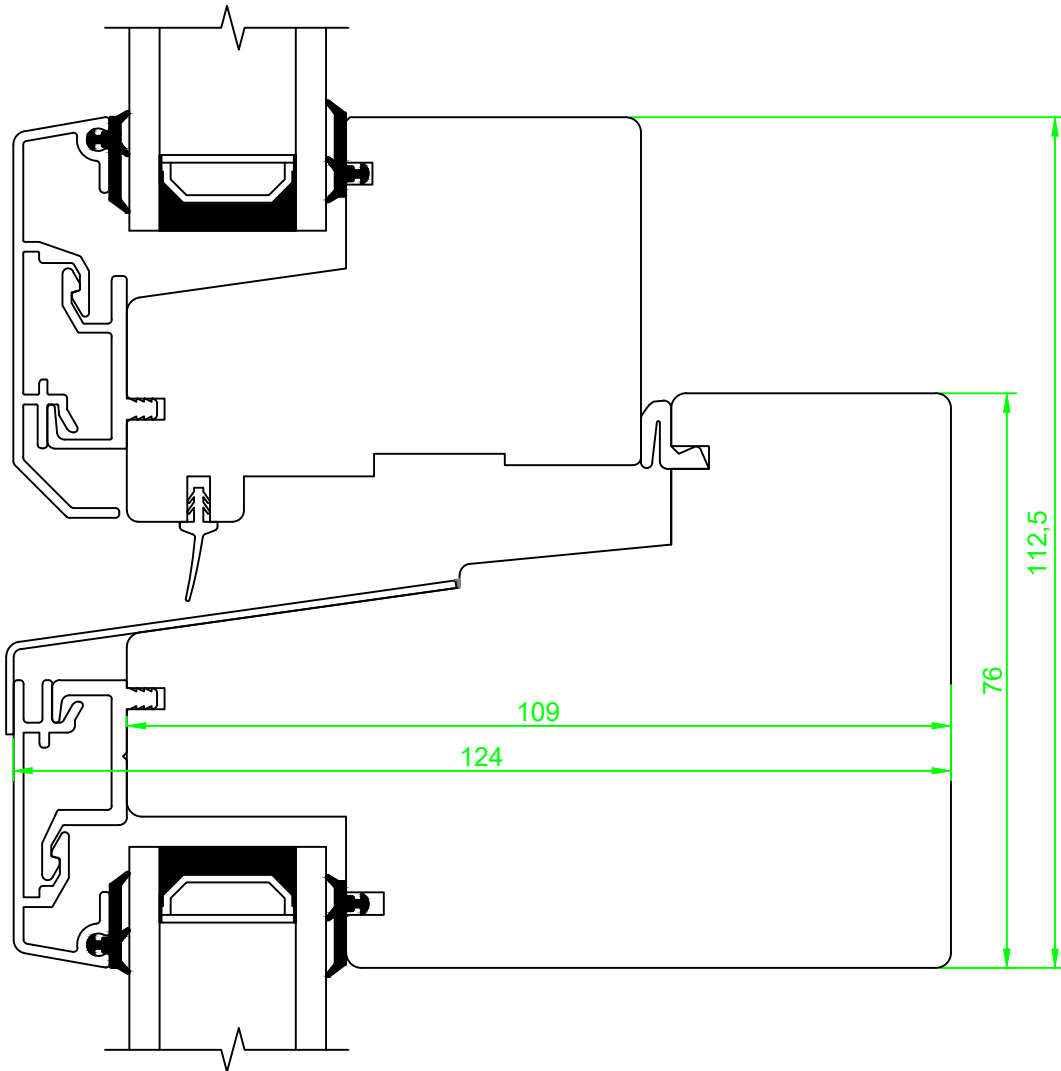
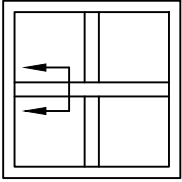

<i>Date.</i> 22.01.2018	<i>Constr./draw.</i> JA/EAO	<i>Approved.</i>	<i>Scale.</i> A4 1:1	<i>Review nr.</i> 5	<i>Review date</i> 30.09.2022	
Fast/sidehengslet vindu i tre/aluminium 109x76 mm losholt, 68mm ramme Vertikalsnitt, design trend			<i>Section:</i>	 <small>Nordvestvinduet AS N-6713 ALMENNINGEN Tel +47 57 85 25 80 firmapost@nordvestvinduet.no www.nordvestvinduet.no</small>		
			<i>Part:</i>			<i>Drawing nr.</i> VUA_TR_R55_L76FU
			<i>Design:</i>			
<i>Tolerance.:</i> NS-ISO 2768-1-middels.						

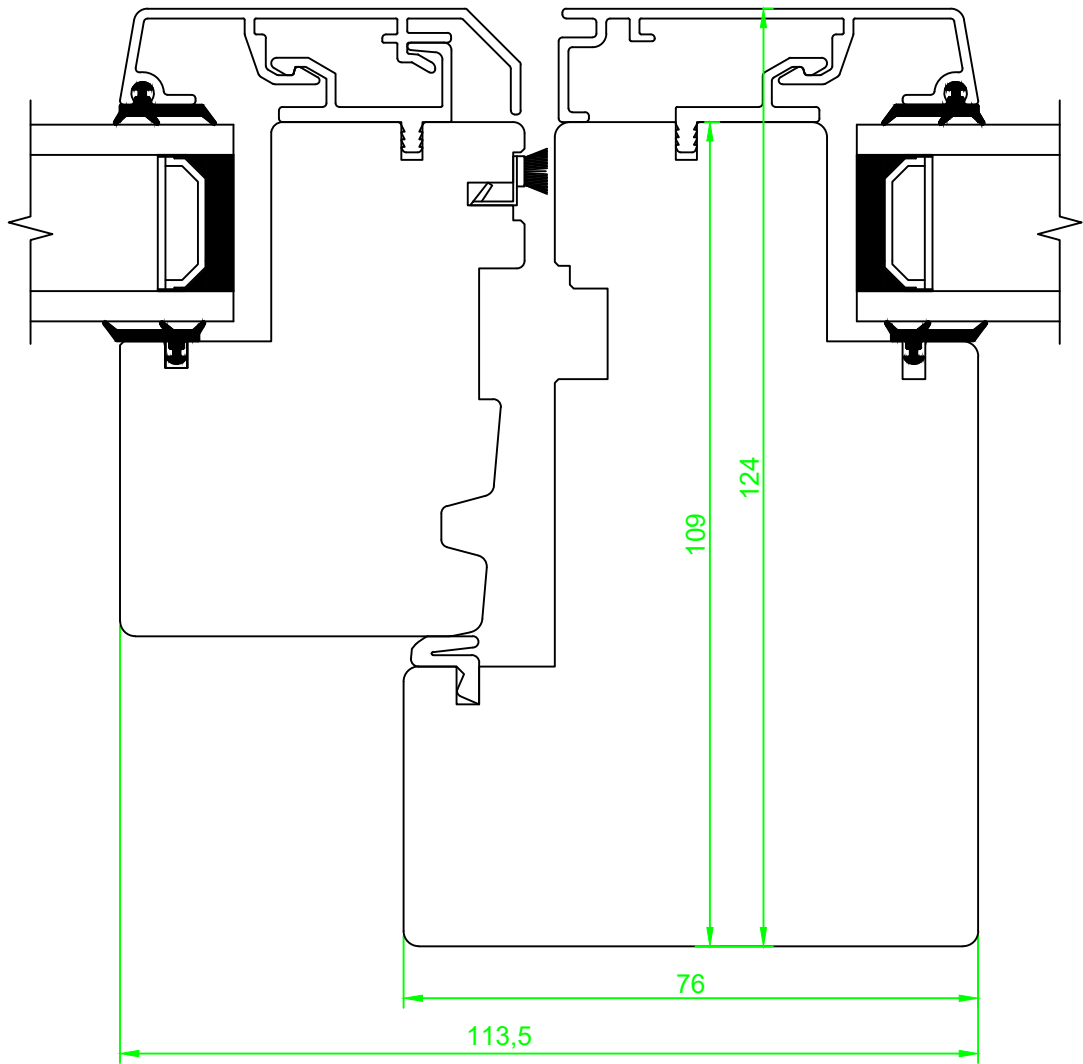
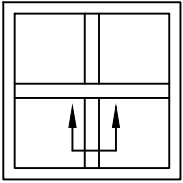

<i>Date.</i> 22.01.2018	<i>Constr./draw.</i> JA/EAO	<i>Approved.</i>	<i>Scale.</i> A4 1:1	<i>Review nr.</i> 5	<i>Review date</i> 30.09.2022
Fast/sidehengslet vindu i tre/aluminium 76mm post, 68mm ramme Horisontalsnitt, design trend			<i>Section:</i>	 <small>Nordvestvinduet AS N-6713 ALMENNINGEN Tel. +47 57 85 25 80 firmapost@nordvestvinduet.no www.nordvestvinduet.no</small>	
			<i>Part:</i>		
			<i>Design:</i>		
<i>Tolerance.:</i> NS-ISO 2768-1-middels.					