

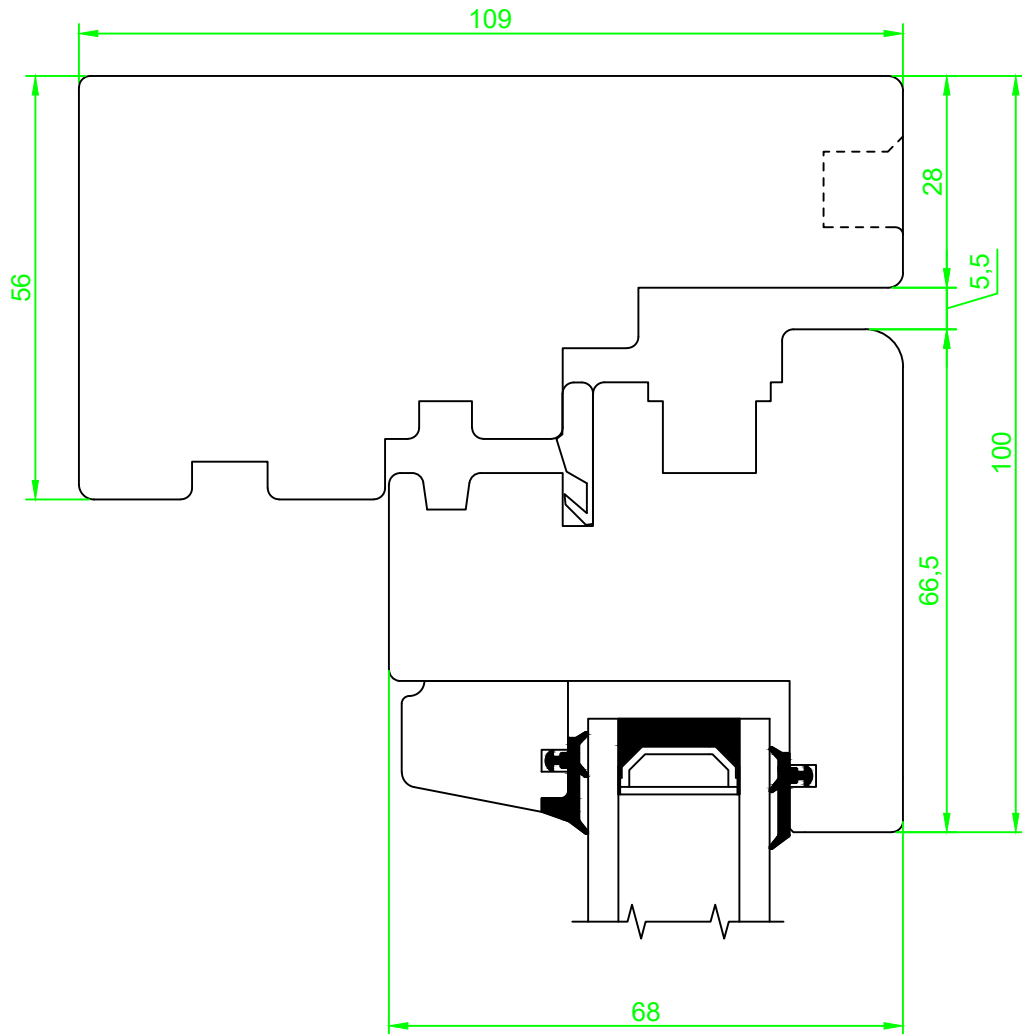

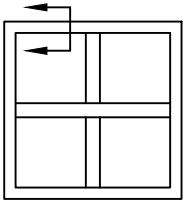

<i>Date.</i> 21.02.2012	<i>Constr./draw.</i> JA/EAO	<i>Approved.</i>	<i>Scale.</i> A4 1:1	<i>Review nr.</i> 3	<i>Review date</i> 28.02.2022
Innslående vindu Ramme 68 mm, glass 24mm			<i>Section:</i> Vertikal	 <small>Nordvestvinduet AS N-6713 ALMENNINGEN Tel +47 57 85 25 80 firmapost@nordvestvinduet.no www.nordvestvinduet.no</small>	
			<i>Part:</i> Bunn		<i>Drawing nr.</i> VIT_R68_G24_B
			<i>Tolerance.:</i> NS-ISO 2768-1-middels.	<i>Design:</i> Trend	



<i>Date.</i> 21.02.2012	<i>Constr./draw.</i> JA/EAO	<i>Approved.</i>	<i>Scale.</i> A4 1:1	<i>Review nr.</i> 3	<i>Review date</i> 28.02.2022
Innslående vindu Ramme 68 mm, glass 24mm			<i>Section:</i> Vertikal	 <small>Nordvestvinduet AS N-6713 ALMENNINGEN Tel +47 57 85 25 80 firmapost@nordvestvinduet.no www.nordvestvinduet.no</small>	
			<i>Part:</i> Topp		
			<i>Tolerance.:</i> NS-ISO 2768-1-middels.	<i>Design:</i> Trend	

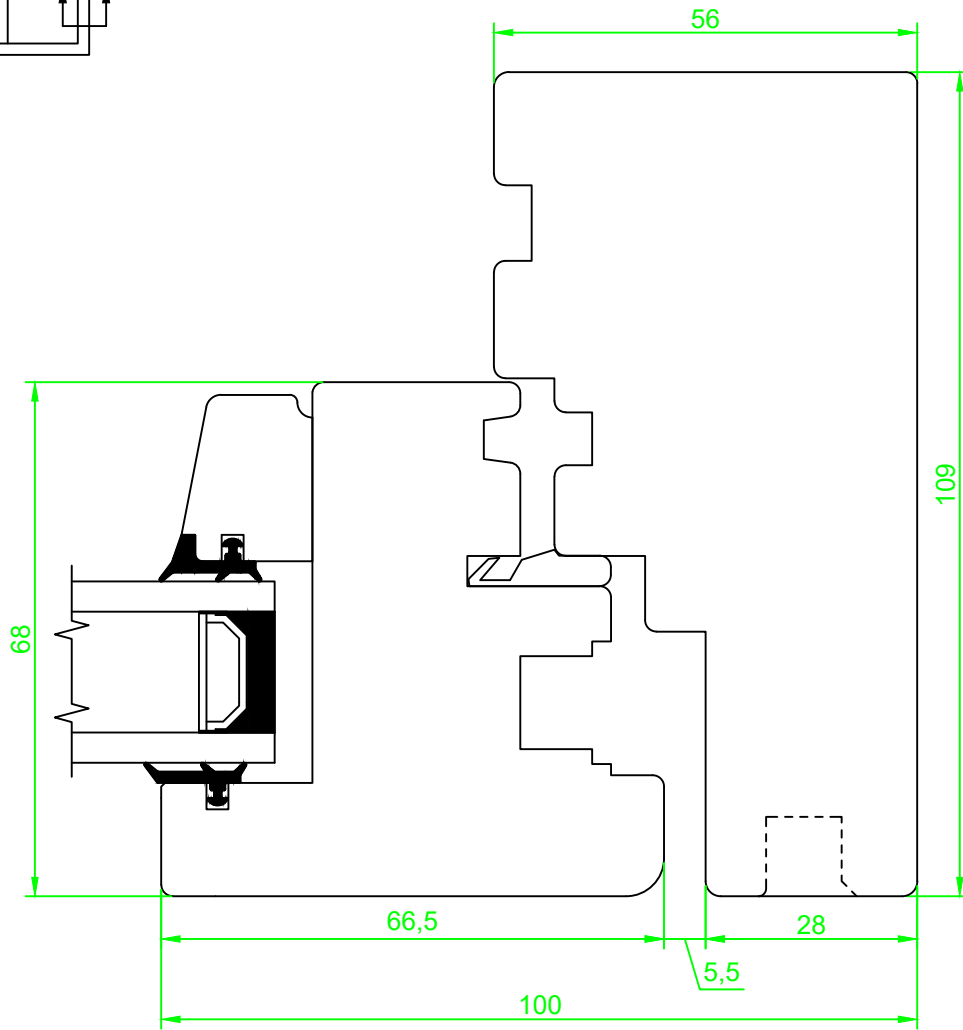
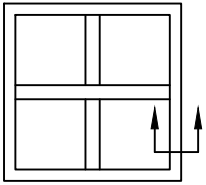

<i>Date.</i> 21.02.2012	<i>Constr./draw.</i> JA/EAO	<i>Approved.</i>	<i>Scale.</i> A4 1:1	<i>Review nr.</i> 3	<i>Review date</i> 28.02.2022
Innslående vindu Ramme 68 mm, glass 24mm			<i>Section:</i> Horisontal	 <small>Nordvestvinduet AS N-6713 ALMENNINGEN Tel +47 57 85 25 80 firmapost@nordvestvinduet.no www.nordvestvinduet.no</small>	
			<i>Part:</i> Side		<i>Drawing nr.</i> VIT_R68_G24_S
			<i>Tolerance.:</i> NS-ISO 2768-1-middels.	<i>Design:</i> Trend	

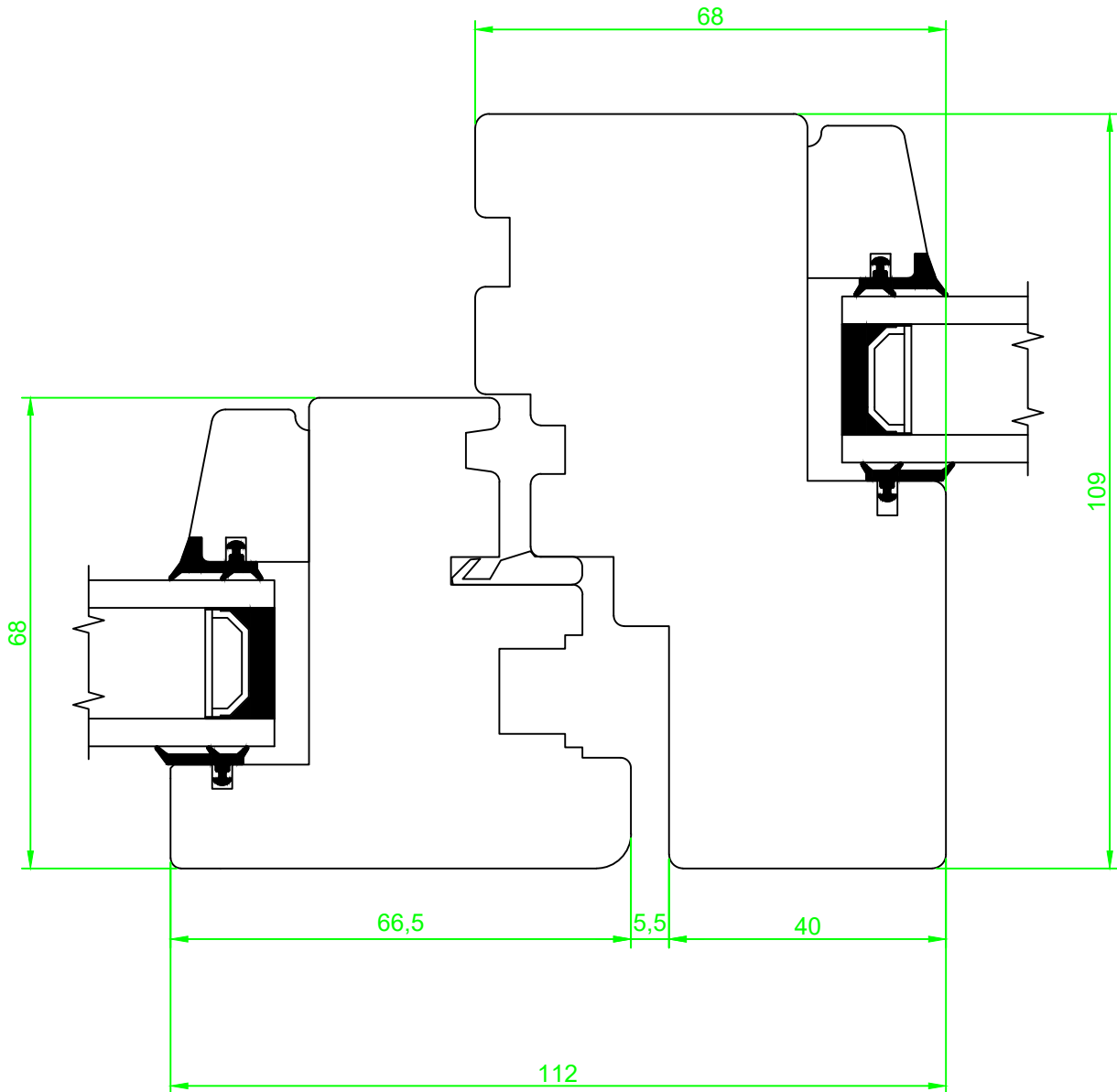
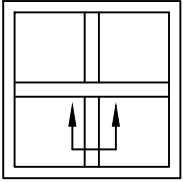

<i>Date.</i> 21.02.2012	<i>Constr./draw.</i> JA/EAO	<i>Approved.</i>	<i>Scale.</i> A4 1:1	<i>Review nr.</i> 3	<i>Review date</i> 28.02.2022
Innslående vindu Ramme 68 mm, glass 24mm			<i>Section:</i> Horisontal	 <small>Nordvestvinduet AS N-6713 ALMENNINGEN Tel +47 57 85 25 80 firmapost@nordvestvinduet.no www.nordvestvinduet.no</small>	<i>Drawing nr.</i> VIT_R68_G24_P68
			<i>Part:</i> Post		
<i>Tolerance.:</i> NS-ISO 2768-1-middels.			<i>Design:</i> Trend		

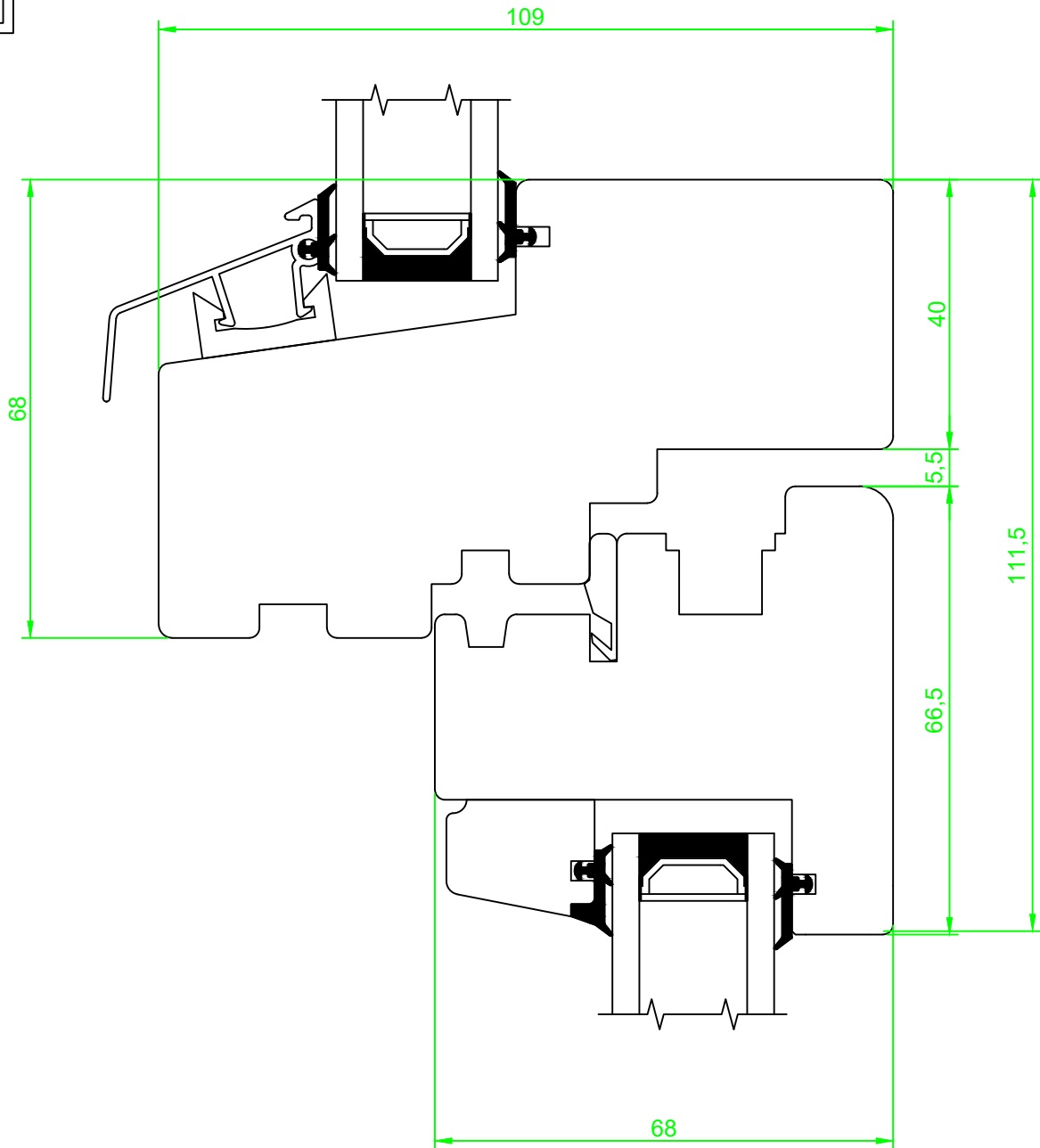
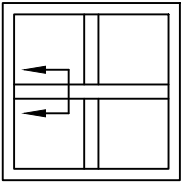

Date. 21.02.2012	Constr./draw. JA/EAO	Approved.	Scale. A4 1:1	Review nr. 3	Review date 28.02.2022
Innslående vindu Ramme 68 mm, glass 24mm			Section: Vertikal	 Nordvestvinduet AS N-6713 ALMENNINGEN Tel: +47 57 85 25 80 firmapost@nordvestvinduet.no www.nordvestvinduet.no	
			Part: Losholt		Drawing nr. VIT_R68_G24_L680
Tolerance.: NS-ISO 2768-1-middels.			Design: Trend		

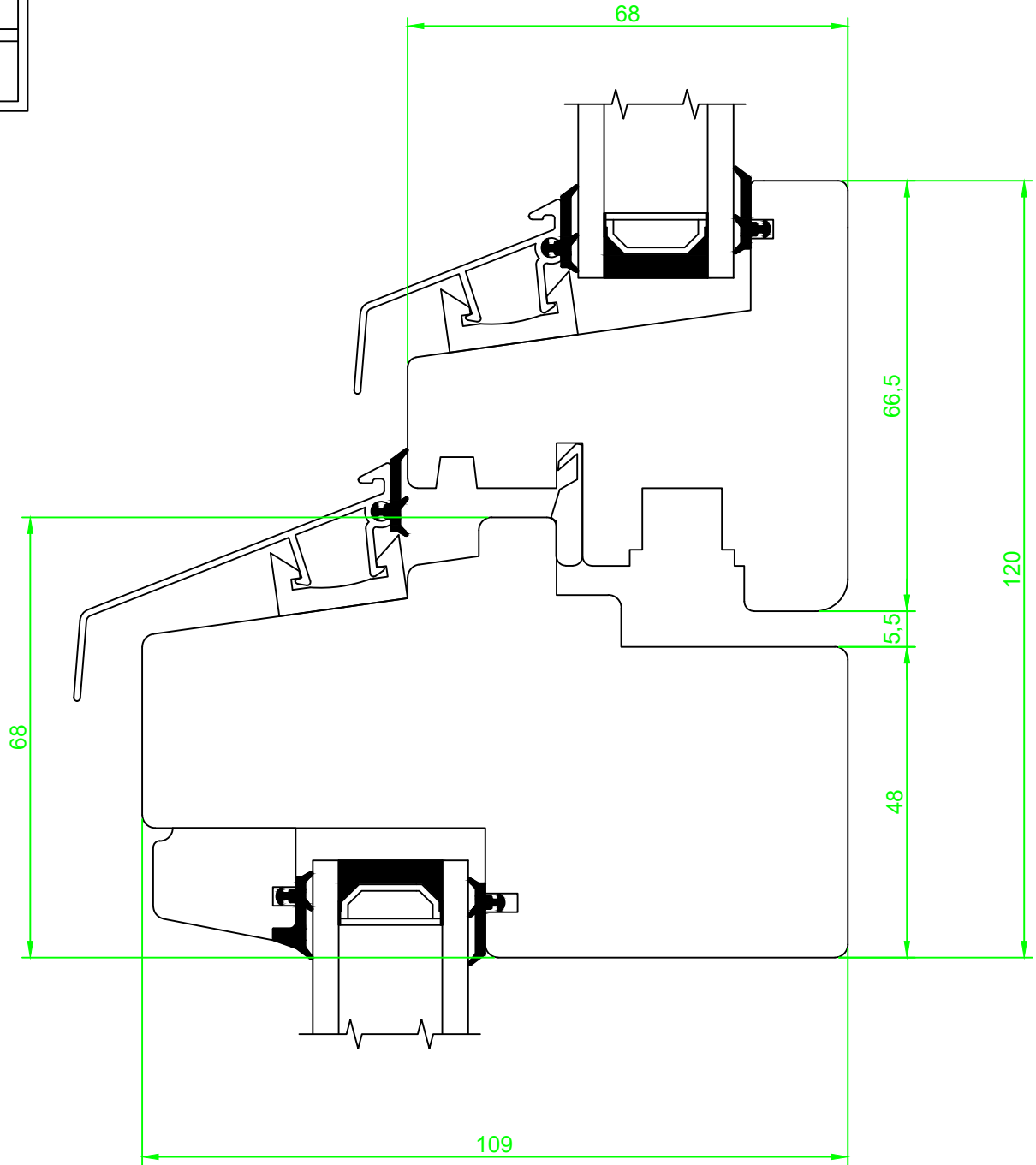
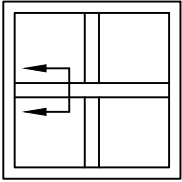

Date. 21.02.2012	Constr./draw. JA/EAO	Approved.	Scale. A4 1:1	Review nr. 3	Review date 28.02.2022
Innslående vindu Ramme 68 mm, glass 24mm			Section: Vertikal	 Nordvestvinduet AS N-6713 ALMENNINGEN Tel +47 57 85 25 80 firma@post@nordvestvinduet.no www.nordvestvinduet.no	Drawing nr. VIT_R68_G24_L68U
			Part: Losholt		
Tolerance.: NS-ISO 2768-1-middels.			Design: Trend		