

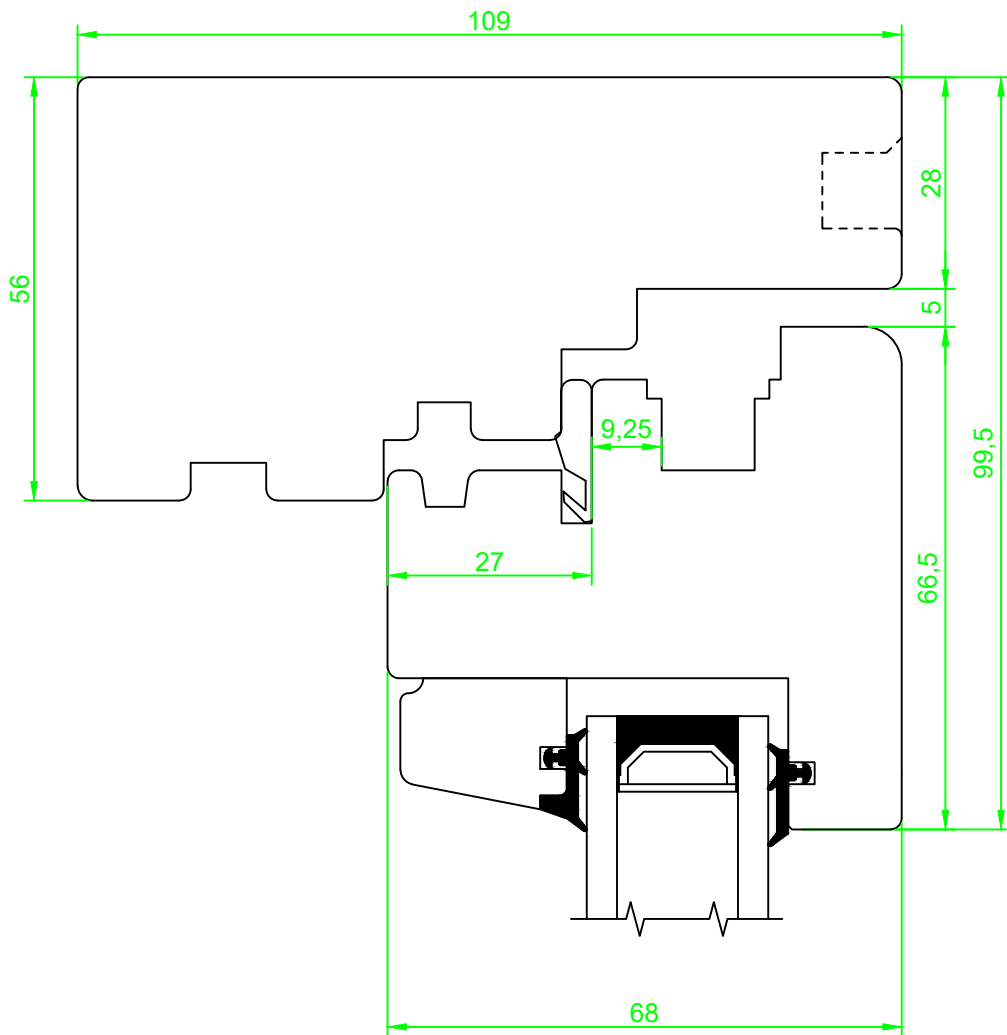

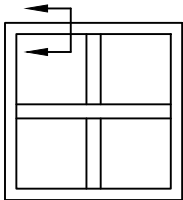

<i>Date.</i> 21.02.2012	<i>Constr./draw.</i> JA/EAO	<i>Approved.</i>	<i>Scale.</i> A4 1:1	<i>Review nr.</i> 3	<i>Review date</i> 06.05.2019
Innvendig innslående vindu Ramme 68 mm, glass 24mm			<i>Section:</i> Vertikal	 Nordvestvinduet AS N-6713 ALMENNINGEN Tel +47 57 85 25 80 firmapost@nordvestvinduet.no www.nordvestvinduet.no	<i>Drawing nr.</i> VII_R68_G24_B
			<i>Part:</i> Bunn		
<i>Tolerance.:</i> NS-ISO 2768-1-middels.			<i>Design:</i> Trend		



<i>Date.</i> 21.02.2012	<i>Constr./draw.</i> JA/EAO	<i>Approved.</i>	<i>Scale.</i> A4 1:1	<i>Review nr.</i> 3	<i>Review date</i> 06.05.2019
Innvendig innslående vindu Ramme 68 mm, glass 24mm			<i>Section:</i> Vertikal	 Nordvestvinduet AS N-8713 ALMENNINGEN Tel +47 57 85 25 80 firmapost@nordvestvinduet.no www.nordvestvinduet.no	
			<i>Part:</i> Topp		<i>Drawing nr.</i> VII_R68_G24_T
<i>Tolerance.:</i> NS-ISO 2768-1-middels.			<i>Design:</i> Trend		

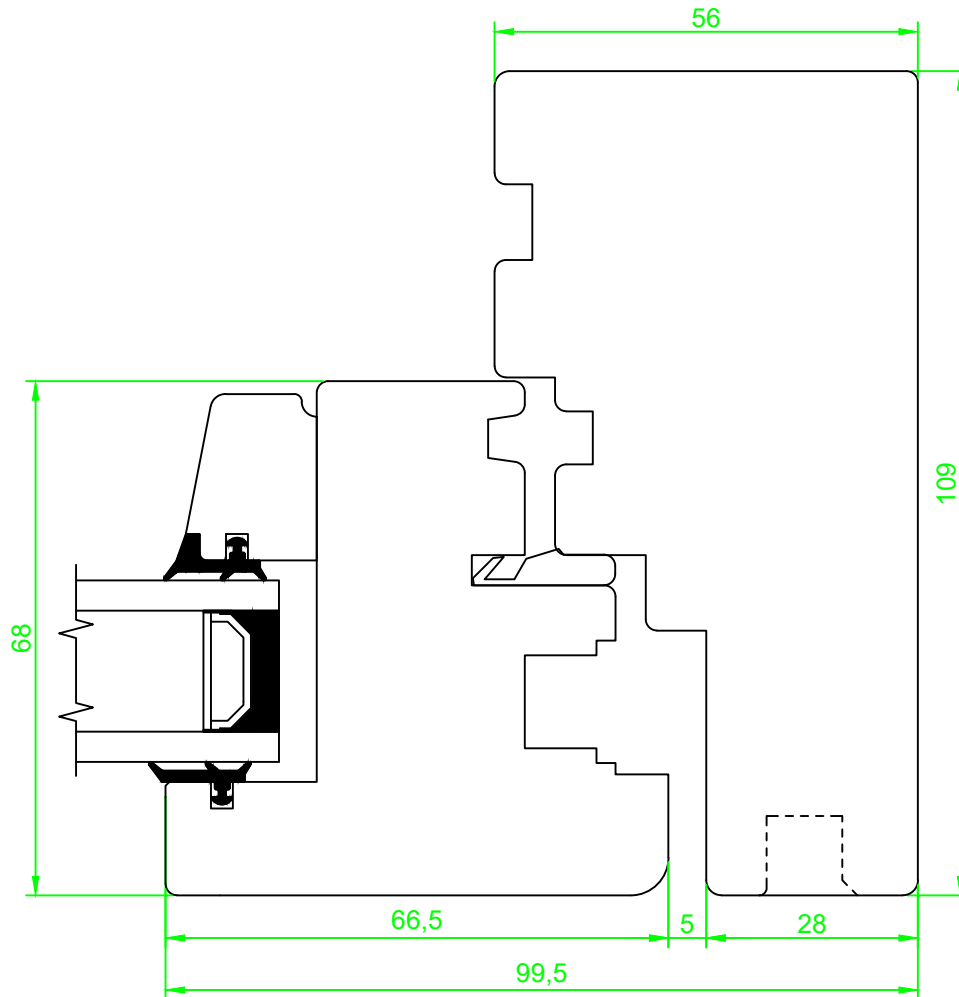
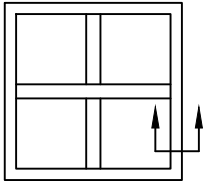

<i>Date.</i> 21.02.2012	<i>Constr./draw.</i> JA/EAO	<i>Approved.</i>	<i>Scale.</i> A4 1:1	<i>Review nr.</i> 3	<i>Review date</i> 06.05.2019
Innvendig innslående vindu Ramme 68 mm, glass 24mm			<i>Section:</i> Horizontal	 Nordvestvinduet AS N-6713 ALMENNINGEN Tel +47 57 85 25 80 firmapost@nordvestvinduet.no www.nordvestvinduet.no	
			<i>Part:</i> Side		<i>Drawing nr.</i> VII_R68_G24_S
			<i>Design:</i> Trend		
<i>Tolerance.:</i> NS-ISO 2768-1-middels.					

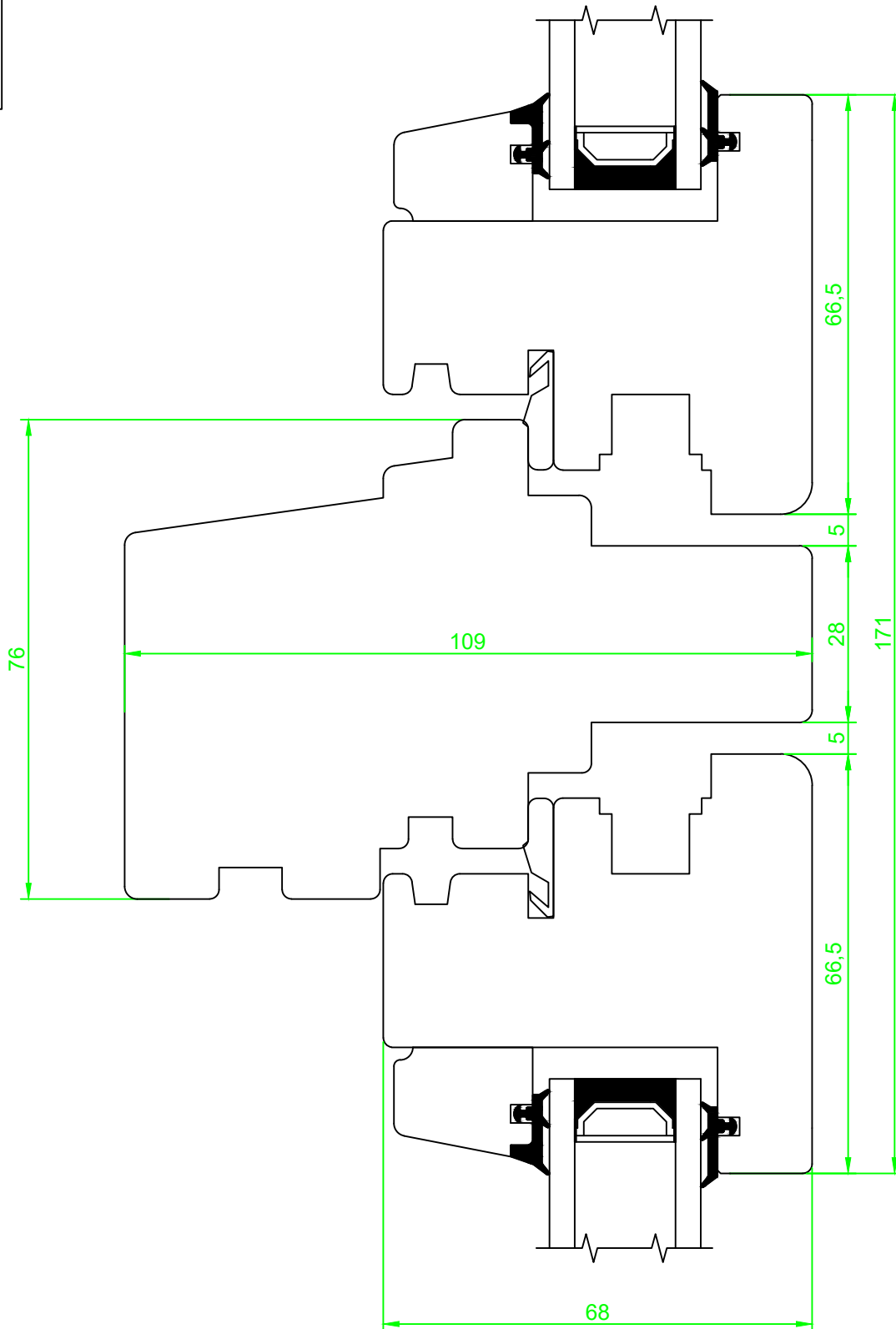
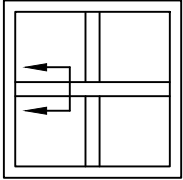

Date. 21.02.2012	Constr./draw. JA/EAO	Approved.	Scale. A4 1:1	Review nr. 3	Review date 06.05.2019
Innvendig innslående vindu Ramme 68 mm, glass 24mm			Section: Vertikal	 Nordvestvinduet AS N-6713 ALMENNINGEN Tel +47 57 85 25 80 firmapost@nordvestvinduet.no www.nordvestvinduet.no	
			Part: Losholt		Drawing nr. VII_R68_G24_L76
			Design: Trend		
Tolerance.: NS-ISO 2768-1-middels.					

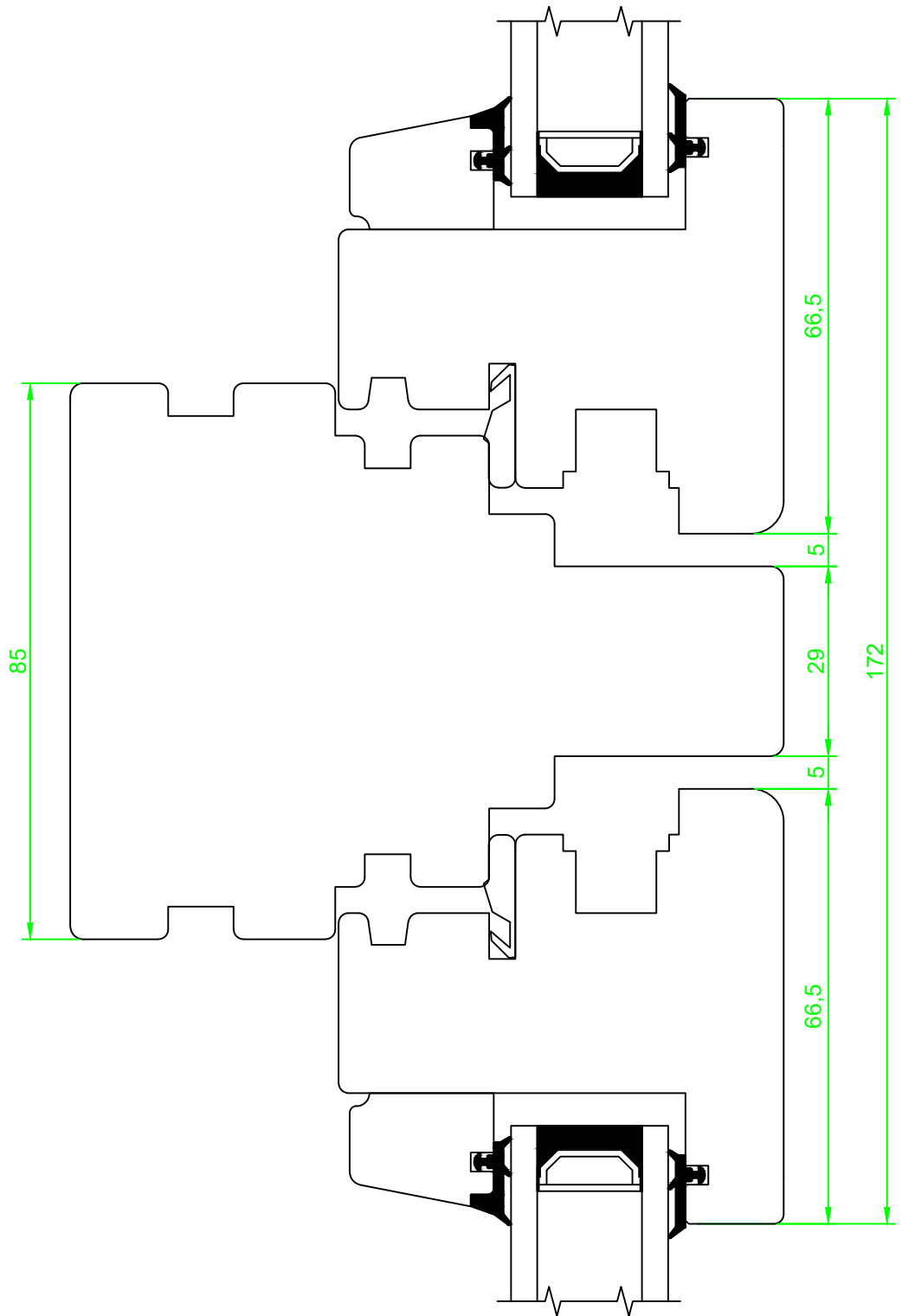
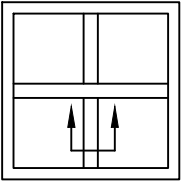

<i>Date.</i> 21.02.2012	<i>Constr./draw.</i> JA/EAO	<i>Approved.</i>	<i>Scale.</i> A4 1:1	<i>Review nr.</i> 3	<i>Review date</i> 06.05.2019
Innvendig innslående vindu Ramme 68 mm, glass 24mm			<i>Section:</i> Horizontal	 <small>Nordvestvinduet AS N-6713 ALMENNINGEN Tel +47 57 85 25 80 firmapost@nordvestvinduet.no www.nordvestvinduet.no</small>	<i>Drawing nr.</i> VII_R68_G24_P85
			<i>Part:</i> Post		
			<i>Design:</i> Trend		
<i>Tolerance.:</i> NS-ISO 2768-1-middels.					

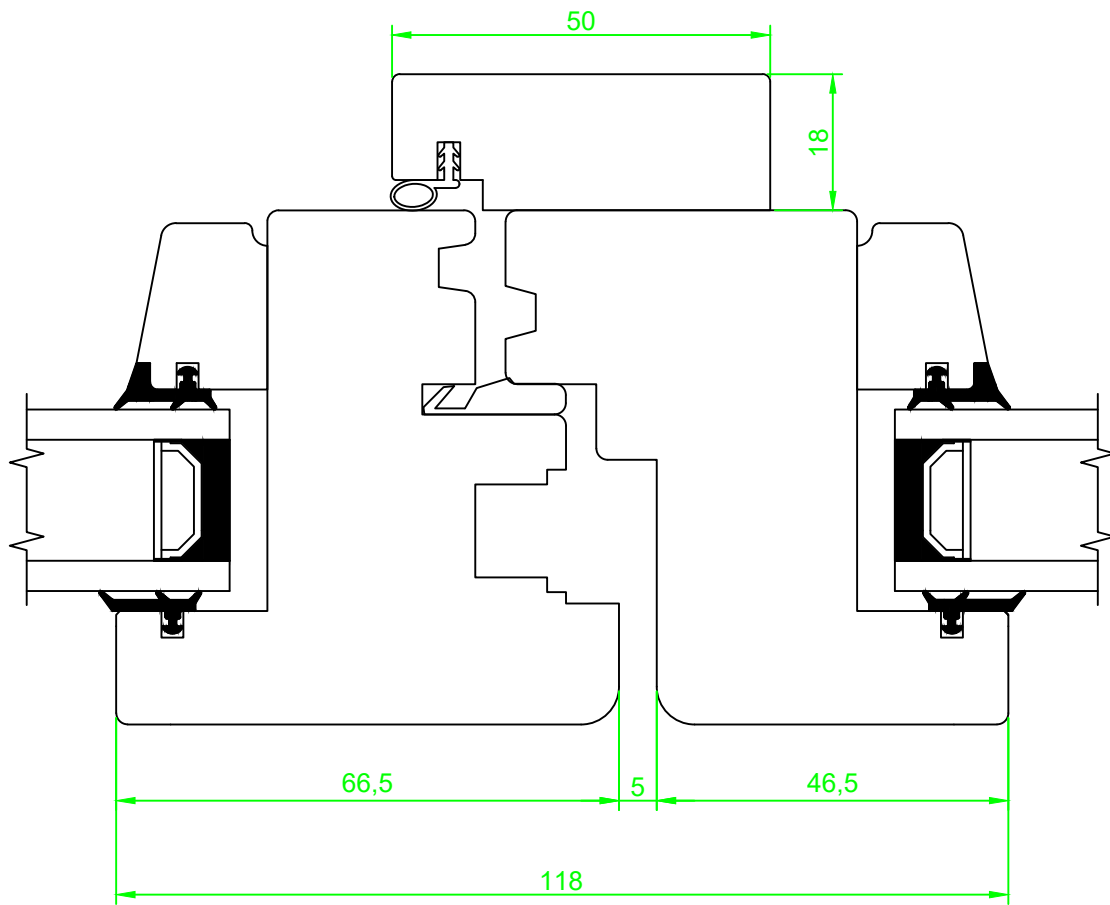
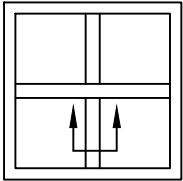

<i>Date.</i> 09.02.2009	<i>Constr./draw.</i> EAO	<i>Approved.</i>	<i>Scale.</i> A4 1:1	<i>Review nr.</i> 3	<i>Review date</i>
Innvendig innslående vindu Ramme 68 mm, glass 24mm			<i>Section:</i> Horisontal	 <small>Nordvestvinduet AS N-6713 ALMENNINGEN Tel +47 57 85 25 80 firmapost@nordvestvinduet.no www.nordvestvinduet.no</small>	
			<i>Part:</i> Stulp		
<i>Tolerance.:</i> NS-ISO 2768-1-middels.			<i>Design:</i> Trend		